

Catalogue | MCX Programmable Controls

Take control of **your HVAC System**  
with unique versatility and freedom

**3**

**programmability**  
levels to perform any  
standard or custom  
control software  
algorithm.



# Index

<b>Index</b>	<b>2</b>
<b>Programmable control</b>	<b>8</b>
MCX06C	8
MCX06D	10
MCX061V	12
MCX08M2	14
MCX152V	16
MCX15B2/MCX20B2	18
<b>User interface module</b>	<b>20</b>
MMIGRS2	20
MMIGRS2CC	22
MMILDS	24
<b>Programmable module</b>	<b>26</b>
MMIMYK	26
ACCGTW	28
<b>Accessory - Speed controller</b>	<b>30</b>
ACCSCS	30
<b>Accessory - Transformers</b>	<b>32</b>
ACCTRD	32
<b>Accessory - Probe</b>	<b>34</b>
ACCPBT	34
<b>Accessory - Cable</b>	<b>35</b>
ACCCBI	35
<b>Accessory - Kit connectors</b>	<b>36</b>
ACCCNX	36

## MCX programmable control system

Versatile and easy-to-use, the MCX's programmable controls can be customised to meet your HVAC / R needs. You can add or remove modules to give you precise control over your HVAC / R environment. And thanks to an array of ACC accessory controls, connecting with other standard communication protocols is easy. This gives you the flexibility to:

- **MCX**
  - Use the MCX as a stand-alone controller, or create a more complex system with expansion modules
- **ACC**
  - With ACC accessory modules, you can connect with supervisor or data logging functions
- **CAN Network**
  - Use the standard built-in CANbus interface as a field-bus to exchange information between controllers and accessories
- **Network communication**
  - Available with built-in RS485 Modbus network communication
- **Communication protocols**
  - Integrate with other communication protocols, such as BACnet, LonWorks and web
- **Language**
  - Tailor the software of any product in the range to your specific requirements using the standard C++ language or the Danfoss MCXDesign graphical programming tool



# Introduction

## Programmability for all

With its range of products, Danfoss aims at extending and widening the concept of programmability by leaving behind the current limits of just high-level applications and expanding it to all possible environments. Programmability therefore becomes the instrument that enables you to adjust the control to the user and not the other way round. Through the development of its application software, Danfoss makes possible to work on several levels:

1. a first level for setting and customising MCX' standard applications. That is an already developed application software that can be 'trimmed' to provide a completely new personalised programme
2. a higher structured language level (from standard C++) for those who are expert enough and prefer to exploit the highest possible detail and potential that a standard programming language can offer
3. a graphical programming tool for those who want to take advantage of programmability in a fast and easy way

## MCX development system

The application software is written in a programming language drawn from C++. We have hidden some of its unsafe functions for the programming of our instruments and at the same time we have made the language simpler and less likely to allow errors. Any text editor can be used to write the programme, however Danfoss recommends the use of specific editors for software development, enabling the highlighting of the syntax, the help online as well as the integration with the compiler and MCX uploader. The elements of the development system are contained in a software package provided by Danfoss and are as follows:

- **a basic function library "MCXLib.lib" and "DisplayLib.lib"**  
These functions, accessed by the developer from inside its software, allow quick and easy use of Danfoss device hardware resources, such as digital and analogue inputs and outputs, serial communication port, CANbus network communication port, LED, buzzer, display, keyboard, etc...
- **a command line compiler "nvmcc.exe"**  
Developed and optimised for MCX controls, it represents the heart of the system, as it allows the "translation" of the software from text format to machine format, (object code), ready to be uploaded into the instrument
- **a programme for uploading the application into the device "nupload.exe"**  
A serial converter makes it possible to interface any PC with MCX controls to perform rapid and safe uploading of the application and for BIOS updating



- **a software simulator**  
To simulate the application without hardware, it performs a rapid debug, integrating external debug instruments for more accurate simulation, tracing all the amendments to the inputs and outputs to allow automatic test repeatability. The simulator may be run with a simple command from the PC without requiring the connection and powering of any device
- **a debugger**  
An essential instrument for software development that enables to analyse, identify and eliminate any "bugs" present in the application by running the programme in small steps, to identify the fragment of the code that generates the problem. The typical characteristics present in the Danfoss debugger include programme running up to the current line, step by step execution, entry of a break point at a preset row, displaying of the value of variables selected during execution, back tracing of the function calls and more
- **a graphical programming environment "MCXDesign"** which allows you to build your HVAC/R application by dragging and connecting basic or more structured logic blocks

With the development environment, Danfoss also provides:

- a demo to use as a basis for creating your own application
- some literature relating to the development system and the software writing editor installation and integration

## Technical specifications

MCX family	MCX06C	MCX06D	MCX061V	MCX08M2	MCX152V	MCX15B2	MCX20B2
<b>ANALOG INPUTS</b>							
NTC	4	4	5	8	14	10	16
0/1 V, 0/5 V	4	4	7	8	14	10	16
0/10 V	2	2	7	8	14	10	16
PT1000	2	2	4	8	8	10	16
0/20 mA, 4/20 mA	2	2	6	4	8	6	10
ON/OFF	2	2	7	4		6	10
<b>Max number</b>	<b>4</b>	<b>4</b>	<b>7</b>	<b>8</b>	<b>14</b>	<b>10</b>	<b>16</b>

<b>DIGITAL INPUTS</b>							
24 V optoisolated					2	4	4
230 V AC optoisolated					2	4	4
Voltage free contact	6	8	8	8	16		
Voltage free/24 V						18	18
<b>Max number</b>	<b>6</b>	<b>8</b>	<b>8</b>	<b>8</b>	<b>18</b>	<b>22</b>	<b>22</b>

<b>ANALOG OUTPUTS</b>							
0/10 V DC	1	2	3	2	6		
0/10 V DC optoisolated				2		6	6
PWM, PPM cutting phase	2	3	1	2	2	2	2
<b>Max number</b>	<b>2</b>	<b>3</b>	<b>3</b>	<b>4</b>	<b>6</b>	<b>6</b>	<b>6</b>

<b>DIGITAL OUTPUTS</b>							
SPST relay 5 A	6	5	6		12	13	18
SPST relay 8 A				2			
SPDT relay 8 A		1		4			
SPST relay 16 A				2	3		
SPDT relay 16 A						2	2
SSR 24 V AC – 230 V AC				2			4
<b>Max number</b>	<b>6</b>	<b>6</b>	<b>6</b>	<b>8</b>	<b>15</b>	<b>15</b>	<b>20</b>

<b>POWER SUPPLY</b>							
24 V AC - 20/60 V DC	•	•	◦	◦	◦	•	•
110/230 V AC – 50/60 Hz			◦	◦	◦	(ultra-wide range)	(ultra-wide range)
Isolated power supply	•	•	•	•	•	•	•

<b>STEPPER MOTOR</b>							
110/230 V AC – 50/60 Hz			1		2		

<b>OTHERS</b>							
Connection for remote MMI and programming key	•	•	•	•	•	•	•
Buzzer		•		•			
CANbus	•	•	•	•	•	•	•
RTC clock	•	◦	•	•	•	•	•
Modbus RS485 optoisolated	1 (not isolated)	1	1	2	2	1	2
Ethernet / Web server			◦		◦	•	•
Memory card slot			•		•		
USB						•	•
Dimensions	33 x 75 mm	4 DIN	8 DIN	8 DIN	16 DIN	16 DIN	16 DIN
Mounting	Panel	DIN rail	DIN rail	DIN rail	DIN rail	DIN rail	DIN rail

## MCX network

MCX system has been formulated along the following concepts:

- **programmability**  
to offer to our customers the opportunity to search for the most suitable customized solution through the MCX programmable controls
- **modular design**  
to optimize ongoing performance of the system through the MCX and expansion controls
- **connectivity**  
to make our products compatible with the most common communication protocols in the market, through the ACC accessory controls
- **user interface**  
to make our products “*user friendly*” in order to facilitate the end user’s programming of the entire system’s function through the MMI controls

MCX system is a global, open and flexible system. The modular architecture of the system has been built using expansion controls, ACC accessory controls and a standard communication protocol (CANbus for local network, Modbus for supervisor network).

The open structure allows connectivity with other standard protocols utilized for the HVAC/R and industrial automation markets. The expansion of the network is possible through a “*plug & play*” system, which provides extremely easy access to shared resources. Through the innovative software programme, the customer has a complete and immediate entry to all the system’s elements. The integrated management of the components and the realization of a system with distributed control has never been so easy...



# MCX network

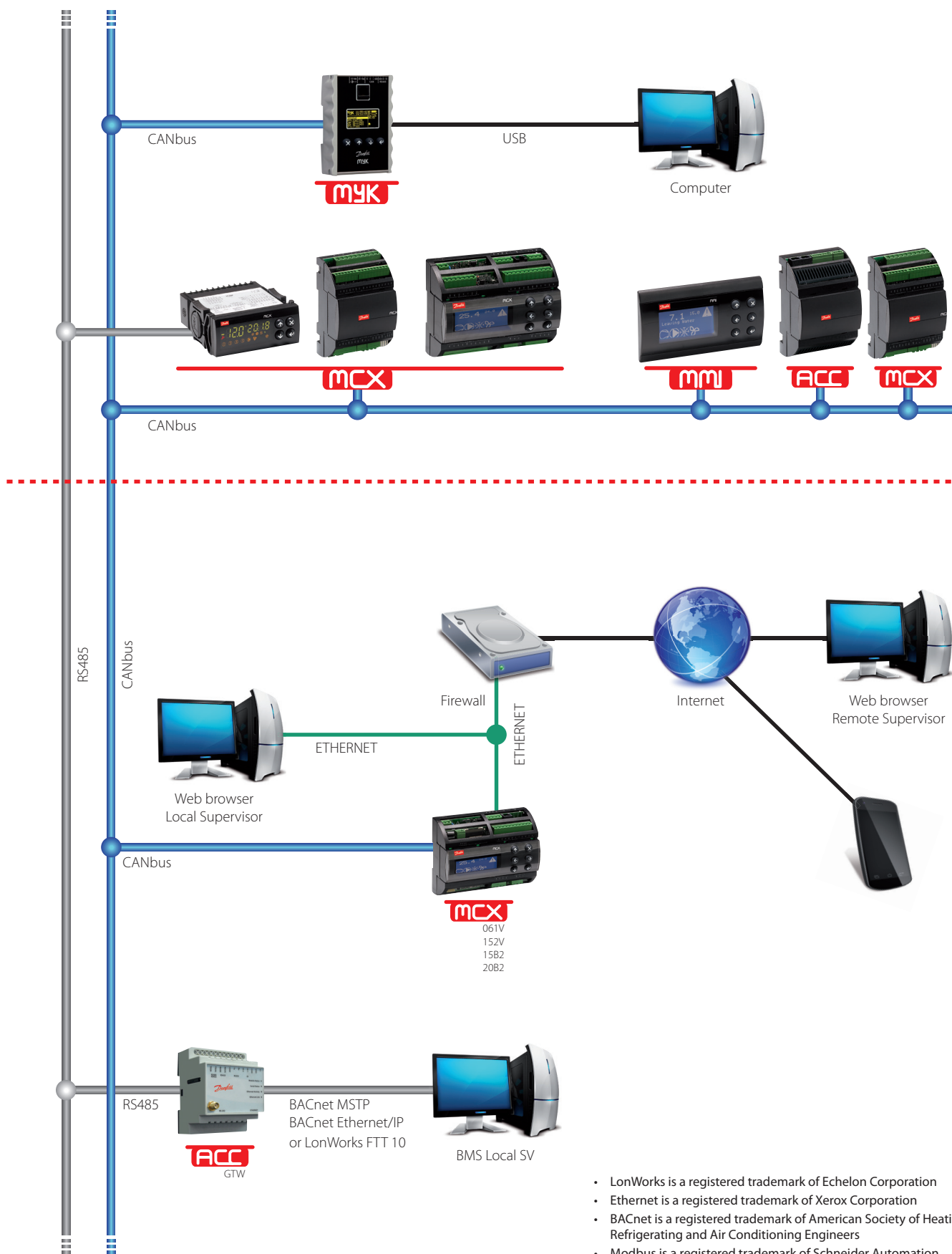

- LonWorks is a registered trademark of Echelon Corporation
- Ethernet is a registered trademark of Xerox Corporation
- BACnet is a registered trademark of American Society of Heating, Refrigerating and Air Conditioning Engineers
- Modbus is a registered trademark of Schneider Automation

# Programmable control

## MCX06C

### Functional description

MCX06C is an electronic controller that holds all the typical functionalities of MCX controllers in the 32 x 74 mm standard size:

- programmability
- connection to the CANbus local network
- Modbus RS485 serial communication interface



### Features

- 4 analog and 6 digital inputs
- 2 analog and 6 digital outputs
- Insulated power supply 20/60 V DC – 24 V AC
- Easy upload of application software through CANbus connection for programming key
- Remote access to data through CANbus connection for additional display (LCD available) and keyboard
- RTC clock for managing weekly time programs and data logging information
- Modbus RS485 serial interface
- Display LED with 2 groups of digits for showing the desired information in one screen
- Dimensions 33 x 75 mm
- Panel mounting

### Approvals

#### CE mark:

This product is designed to comply with the following EU standards:

- Low voltage directive LVD 2014/35/EU:
  - EN60730-1: 2011 (Automatic electrical control for household and similar use. General requirements)
  - EN60730-2-9: 2010 (Particular requirements for temperature sensing controls)
- Electromagnetic compatibility EMC directive 2014/30/EU:
  - EN 61000-6-3: 2007 +A1: 2011 (Emission standard for residential, commercial and light-industrial environments)
  - EN 61000-6-2: 2005 (Immunity for industrial environments)
- RoHS directive 2011/65/EU and 2015/863/EU:
  - EN50581: 2012

#### UL approval:

- UL file E31024

### Product part numbers

DESCRIPTION	CODE NO.
MCX06C, 24 V, LED, RS485, RTC, S	080G0066
MCX06C, 24 V, LED, RS485, RTC, I	080G0107

*Note: single pack codes (S) don't include standard kit connectors, industrial pack codes (I) don't include standard kit connectors*



# Programmable control

## MCX06C

### Dimensions

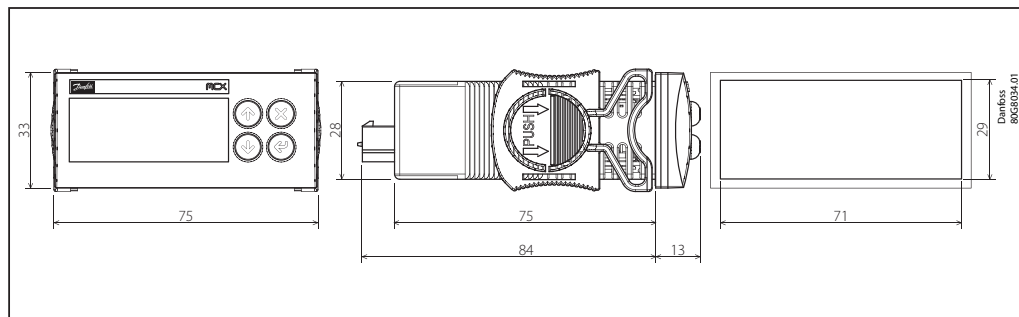

### Technical data

	MCX06C
<b>ANALOG INPUTS</b>	
NTC, 0/1 V, 0/5 V, selectable via software	2
Universal NTC, PT1000, 0/1 V, 0/5 V, 0/10 V, ON/OFF, 0/20 mA, 4/20 mA, selectable via software	2
<b>Total number</b>	<b>4</b>
<b>DIGITAL INPUTS</b>	
Voltage free contact	6
<b>Total number</b>	<b>6</b>
<b>ANALOG OUTPUTS</b>	
0/10 V DC, PWM, PPM selectable via software	1
PWM, PPM selectable via software	1
<b>Total number</b>	<b>2</b>
<b>DIGITAL OUTPUTS</b>	
SPST relay 5 A (normally open contacts)	6
<b>Total number</b>	<b>6</b>
<b>OTHERS</b>	
Insulated power supply 20/60 V DC – 24 V AC	•
Connection for programming key	•
Connection for remote display and keyboard	•
Buzzer	
CANbus	•
RTC clock	◦
Modbus RS485 serial interface	•
Dimensions (mm)	33 × 75 mm
Mounting	Panel

# Programmable control

## MCX06D

### Functional description

MCX06D is fitted with graphic LCD display or without display. It is an electronic controller that holds all the typical functionalities of MCX controllers in the compact size of 4 DIN modules:

- programmability
- connection to the CANbus local network
- Modbus RS485
- opto-insulated serial interface



### Features

- 4 analog and 8 digital inputs
- 3 analog and 6 digital outputs
- Power supply 20/60 V DC – 24 V AC
- Remote access to data through CANbus connection for additional display (LCD available) and keyboard
- RTC clock for managing weekly time programs
- Modbus RS485 opto-insulated serial interface
- Available with graphic LCD display or without display for showing the desired information
- Dimensions 4 DIN modules

### Approvals

#### CE mark:

This product is designed to comply with the following EU standards:

- Low voltage directive LVD 2014/35/EU:
  - EN60730-1: 2011 (Automatic electrical control for household and similar use. General requirements)
  - EN60730-2-9: 2010 (Particular requirements for temperature sensing controls)
- Electromagnetic compatibility EMC directive 2014/30/EU:
  - EN 61000-6-3: 2007 +A1: 2011 (Emission standard for residential, commercial and light-industrial environments)
  - EN 61000-6-2: 2005 (Immunity for industrial environments)
- RoHS directive 2011/65/EU and 2015/863/EU:
  - EN50581: 2012

#### UL approval:

- UL file E31024

### Product part numbers

DESCRIPTION	CODE NO.
MCX06D, 24 V, LCD, S	080G0111
MCX06D, 24 V, LCD, RS485, RTC, S	080G0112
MCX06D, 24 V, RS485, RTC, S	080G0115
MCX06D, 24 V, LCD, I	080G0166
MCX06D, 24 V, LCD, RS485, RTC, I	080G0167
MCX06D, 24 V, RS485, RTC, I	080G0169

**Note:** single pack codes (S) include standard kit connectors, industrial pack codes (I) don't include standard kit connectors

# Programmable control

## MCX06D

### Dimensions

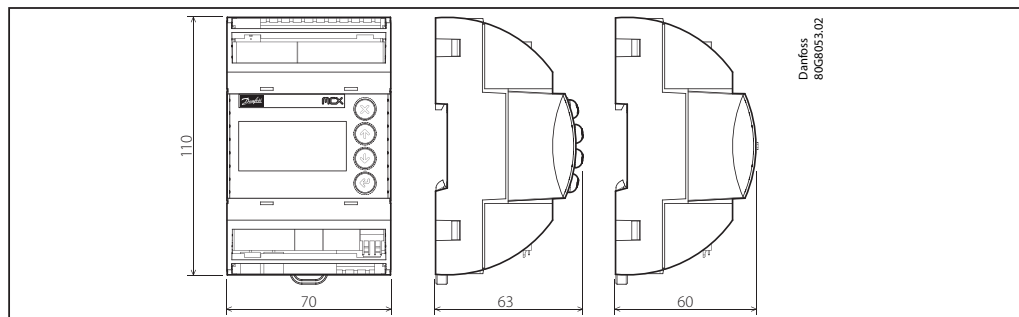

### Technical data

	<b>MCX06D</b>
<b>ANALOG INPUTS</b>	
NTC, 0/1 V, 0/5 V, selectable via software	2
Universal NTC, PT1000, 0/1 V, 0/5 V, 0/10 V, ON/OFF, 0/20 mA, 4/20 mA, selectable via software	2
<b>Total number</b>	<b>4</b>
<b>DIGITAL INPUTS</b>	
Voltage free contact	8
<b>Total number</b>	<b>8</b>
<b>ANALOG OUTPUTS</b>	
0/10 V DC, PWM, PPM selectable via software	2
PWM, PPM selectable via software	1
<b>Total number</b>	<b>3</b>
<b>DIGITAL OUTPUTS</b>	
SPST relay 5 A (normally open contacts)	5
SPDT relay 8 A (changeover contacts)	1
<b>Total number</b>	<b>6</b>
<b>OTHERS</b>	
Insulated power supply 20/60 V DC – 24 V AC	•
Connection for programming key	•
Connection for remote display and keyboard	•
Buzzer	•
CANbus	•
RTC clock	•
Modbus RS485 serial interface	•
Dimensions (DIN modules)	4
Mounting	DIN rail

# Programmable control

## MCX061V

### Functional description

MCX061V is a standard MCX electronic controller with one integrated electronic expansion valve driver. It is available in the version with graphic LCD display and 110/230 V AC or 24 V AC power supply.

It holds all the typical functionalities of MCX controllers in the compact size of 8 DIN modules: programmability, connection to the CANbus local network, Modbus RS485 serial communication interface. It is moreover fitted with a slot for memory card SD / MMC and Ethernet connection. The memory card assures SW download and datalogging function; the Ethernet port allows the SW download, monitoring with web pages, datalogging and the alarms warning.



### Features

- 7 analog and 8 digital inputs
- 3 analog and 6 digital outputs
- Power supply 24 V AC and 110 V / 230 V AC
- Drives bipolar and unipolar electronic expansion valves
- SD / MMC card slot for easy software upload and datalogging
- Remote access to data through CANbus connection for additional display and keyboard
- RTC clock for managing weekly time programs and data logging information
- Ethernet / WebServer option
- Modbus RS485 opto-insulated serial interface
- Available with graphic LCD display for showing the desired information
- Dimensions 8 DIN modules

### Approvals

#### CE mark:

This product is designed to comply with the following EU standards:

- Low voltage directive LVD 2014/35/EU:
  - EN60730-1: 2011 (Automatic electrical control for household and similar use. General requirements)
  - EN60730-2-9: 2010 (Particular requirements for temperature sensing controls)
- Electromagnetic compatibility EMC directive 2014/30/EU:
  - EN 61000-6-4: 2007 +A1: 2011 (Emissions standard for industrial environments)
  - EN 61000-6-2: 2005 (Immunity for industrial environments)
- RoHS directive 2011/65/EU and 2015/863/EU:
  - EN50581: 2012

#### UL approval:

- UL file E31024

### Product part numbers

DESCRIPTION	CODE NO.
MCX061V, 230 V, LCD, RS485, RTC, S	080G0250
MCX061V, 24 V, LCD, RS485, RTC, S	080G0251
MCX061V, 24 V, LCD, RS485, RTC, ETH, S	080G0255

**Note:** single pack codes (S) include standard kit connectors

# Programmable control

## MCX061V

### Dimensions

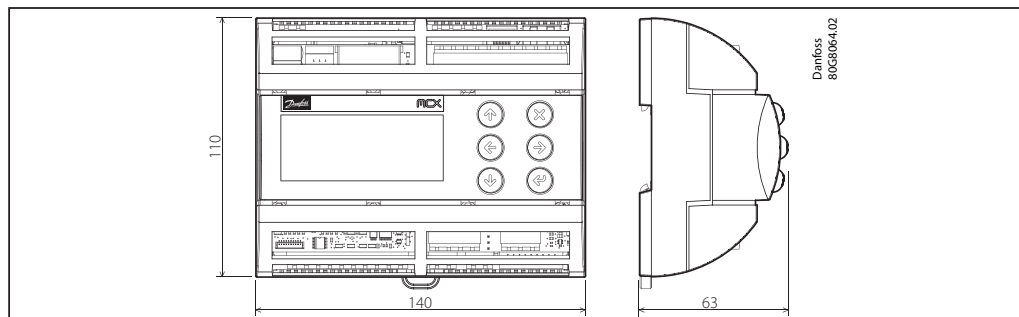

### Technical data

	MCX061V
<b>ANALOG INPUTS</b>	
NTC, PT1000, 0/1 V, 0/5 V, 0/10 V, ON/OFF, 0/20 mA, 4/20 mA, selectable via software	3
NTC, 0/1 V, 0/5 V, 0/10 V, ON/OFF, 0/20 mA, 4/20 mA, selectable via software	2
Superheat S1: 0/1 V, 0/5 V, 0/10 V, ON/OFF, 0/20 mA, 4/20 mA, selectable via software	1
Superheat S2: PT1000, 0/1 V, 0/5 V, 0/10 V, ON/OFF, selectable via software	1
<b>Total number</b>	<b>7</b>
<b>DIGITAL INPUTS</b>	
Voltage free contact	8
<b>Total number</b>	<b>8</b>
<b>ANALOG OUTPUTS</b>	
0/10 V DC	2
0/10 V, PWM, PPM selectable via software	1
<b>Total number</b>	<b>3</b>
<b>DIGITAL OUTPUTS</b>	
SPST relay 5 A (normally open contacts)	6
<b>Total number</b>	<b>6</b>
<b>OTHERS</b>	
Power supply 24 V AC	•
Power supply 110 V – 230 V AC	•
Connection for programming key	•
Connection for remote display and keyboard	•
CANbus	•
RTC clock	•
Modbus RS485 serial interface	•
Ethernet / Webservice	◦
SD (Secure Digital) or MMC (Multi Media Card) expansion slot up to 32 GB	•
Bipolar and unipolar motor output	•
Datalogging	•
Dimensions (DIN modules)	8
Mounting	DIN rail

# Programmable control

## MCX08M2

### Functional description

MCX08M2 is an electronic controller that holds all the typical functionalities of MCX controllers in the compact size of 8 DIN modules:

- programmability
- connection to the CANbus local network
- Modbus RS485 opto-insulated serial interface

It is available in the version with or without graphic LCD display, and 110 / 230 V AC or 24 V AC power supply



### Features

- 8 analog and 8 digital inputs
- 4 analog and 8 digital outputs
- Power supply 24 V AC / 20 / 60 V DC and 110 V / 230 V AC
- Remote access to data through CANbus connection for additional display (LCD available) and keyboard
- RTC clock for managing weekly time programs and data logging information
- Modbus RS485 opto-insulated serial interface
- Dimensions 8 DIN modules
- Available with graphic LCD display and without display for showing the desired information

### Approvals

#### CE mark:

This product is designed to comply with the following EU standards:

- Low voltage directive LVD 2014/35/EU:
  - EN60730-1: 2011 (Automatic electrical control for household and similar use. General requirements)
  - EN60730-2-9: 2010 (Particular requirements for temperature sensing controls)
- Electromagnetic compatibility EMC directive 2014/30/EU:
  - EN 61000-6-3: 2007 +A1: 2011 (Emission standard for residential, commercial and light-industrial environments)
  - EN 61000-6-2: 2005 (Immunity for industrial environments)
- RoHS directive 2011/65/EU and 2015/863/EU:
  - EN50581: 2012

#### UL approval:

- UL file E31024

### Product part numbers

DESCRIPTION	CODE NO.
MCX08M2, 24 V, RS485, RTC, Single Pack	080G0293
MCX08M2, 230 V, LCD, RS485, RTC, Single Pack	080G0307
MCX08M2, 24 V, LCD, RS485, RTC, Single Pack	080G0310
MCX08M2, 24 V, RS485, RTC, Industrial Pack (24 pieces)	080G0303
MCX08M2, 230 V, RS485, RTC, 2SSR, Industrial Pack (24 pieces)	080G0314
MCX08M2, 24 V, LCD, RS485, RTC, Industrial Pack (24 pieces)	080G0315
MCX08M2, 230 V, RS485, RTC, Industrial Pack (24 pieces)	080G0316

*Note: industrial pack codes (I) don't include standard kit connectors*

# Programmable control

## MCX08M2

### Dimensions

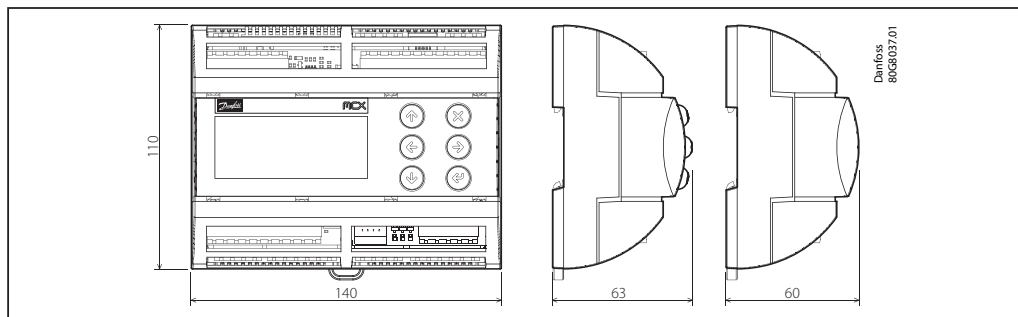

### Technical data

	MCX08M2
<b>ANALOG INPUTS</b>	
NTC, 0/1 V, 0/5 V, 0/10 V, PT1000, selectable via software	4
Universal NTC, PT1000, 0/1 V, 0/5 V, 0/10 V, ON/OFF, 0/20 mA, 4/20 mA, selectable via software	4
<b>Total number</b>	<b>8</b>
<b>DIGITAL INPUTS</b>	
Voltage free contact	8
<b>Total number</b>	<b>8</b>
<b>ANALOG OUTPUTS</b>	
0/10 V DC optoinsulated	2
0/10 V DC, PWM, PPM, selectable via software	2
<b>Total number</b>	<b>4</b>
<b>DIGITAL OUTPUTS</b>	
SPST relay 16 A (normally open contacts)	2
SPST relay 8 A (normally open contacts)	2
SPDT relay 8 A (changeover contacts)	4
<b>Total number</b>	<b>8</b>
<b>OTHERS</b>	
Power supply 24 V AC – 20/60 V DC	•
Power supply 110 V – 230 V AC	•
Connection for programming key	•
Connection for remote display and keyboard	•
Buzzer	•
CANbus	•
RTC clock	•
Modbus RS485 serial interface	•
Dimensions (DIN modules)	8
Mounting	DIN rail

# Programmable control

## MCX152V

### Functional description

MCX152V is a standard MCX electronic controller that stands on the top of MCX range thanks to its large number of input and output and two integrated electronic expansion valves drivers. It is available in the version with or without graphic LCD display, and 110 V/230 V AC or 24 V AC power supply. It holds all the typical functionalities of MCX controllers: programmability, connection to the CANbus local network and up to two Modbus RS485 serial communication interfaces. It is moreover fitted with the slot for SD / MMC memory card and Ethernet connector.

The memory card assures SW and bios download; the ethernet port allows the monitoring with the web pages, the SW and bios download, the data logging and the warning for the alarms.



### Features

- 14 analog and 18 digital inputs
- 6 analog and 15 digital outputs
- Power supply 24 V AC and 110 V – 230 V AC
- Up to two drives bipolar and unipolar electronic expansion valves
- SD / MMC card slot for easy software upload and datalogging
- Remote access to data through CANbus connection for additional display and keyboard
- RTC clock for managing weekly time programs and data logging information
- Ethernet / WebServer option
- Two Modbus RS485 opto-insulated serial interface
- Available with graphic LCD display and without display for showing the desired information
- Dimensions 16 DIN modules

### Approvals

#### CE mark:

This product is designed to comply with the following EU standards:

- Low voltage directive LVD 2014/35/EU:
  - EN60730-1: 2011 (Automatic electrical control for household and similar use. General requirements)
  - EN60730-2-9: 2010 (Particular requirements for temperature sensing controls)
- Electromagnetic compatibility EMC directive 2014/30/EU:
  - EN 61000-6-4: 2007 +A1: 2011 (Emissions standard for industrial environments)
  - EN 61000-6-2: 2005 (Immunity for industrial environments)
- RoHS directive 2011/65/EU and 2015/863/EU:
  - EN50581: 2012

#### UL approval:

- UL file E31024

### Product part numbers

DESCRIPTION	CODE NO.
MCX152V, 24 V, LCD, 2XRS485, ETH, S	080G0284
MCX152V, 230 V, LCD, 2XRS485, ETH, S	080G0285
MCX152V, 24 V, 2XRS485, S	080G0313

**Note:** single pack codes (S) include standard kit connectors



# Programmable control

## MCX152V

### Dimensions

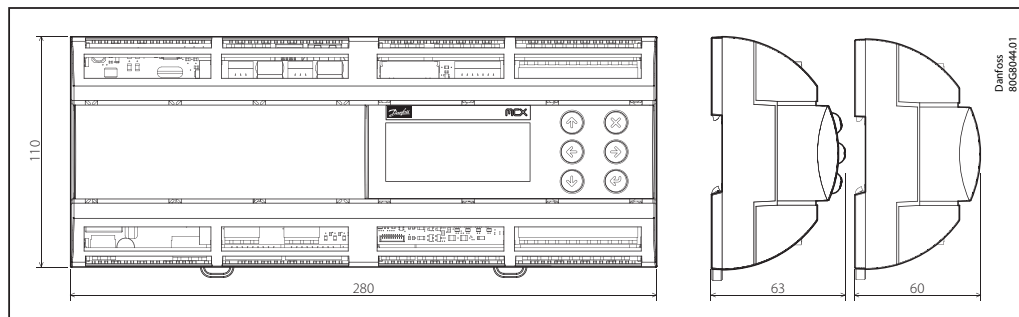

### Technical data

	MCX152V
<b>ANALOG INPUTS</b>	
NTC, PT1000, 0/1 V, 0/5 V, 0/10 V, 0/20 mA, 4/20 mA, selectable via software	8
NTC, 0/1 V, 0/5 V, 0/10 V, 0/20 mA, 4/20 mA, selectable via software	6
Superheat S1: 0/1 V, 0/5 V, 0/10 V, 0/20 mA, 4/20 mA, selectable via software	2
Superheat S2: PT1000, 0/1 V, 0/5 V, 0/10 V, selectable via software	2
<b>Total number</b>	<b>14</b>
<b>DIGITAL INPUTS</b>	
Voltage free contact	16
24 V optoinsulated	2
230 V AC optoinsulated	2
<b>Total number</b>	<b>18</b>
<b>ANALOG OUTPUTS</b>	
0/10 V DC	6
0/10 V, PWM, PPM selectable via software	2
<b>Total number</b>	<b>6</b>
<b>DIGITAL OUTPUTS</b>	
SPST relay 5 A (normally open contacts)	12
SPDT relay 16 A (changeover contacts)	3
<b>Total number</b>	<b>15</b>
<b>OTHERS</b>	
Power supply 24 V AC	•
Power supply 110 V – 230 V AC	•
Connection for programming key	•
Connection for remote display and keyboard	•
CANbus	•
RTC clock	•
Modbus RS485 serial interface	•
Ethernet / Webservice	•
SD (Secure Digital) or MMC (Multi Media Card) expansion slot up to 32 GB	•
Bipolar and unipolar motor output	•
Dimensions (DIN modules)	16
Mounting	DIN rail

# Programmable control

## MCX15B2/MCX20B2

### Functional description

MCX15B2/MCX20B2 is an electronic controller that stands on the top of the MCX range, thanks to the large number of its inputs and outputs, the enhanced CPU capabilities and connectivity features.

It holds all the typical functionalities of MCX controllers:

- programmability
- connection to the CANbus local network
- up to two Modbus RS485 serial interfaces with galvanic isolation.

Furthermore, it is fitted with an ultra wide range (24/110/230 V AC) power supply in the same product variant, with USB and Ethernet connection for embedded Web server and IP protocols management.

It is available in several models, with or without graphic LCD display and with 15 or 20 digital output.



### Features

MCX20B2:

- 16 analog and 22 digital inputs
- 6 analog and 20 digital outputs

MCX15B2:

- 10 analog and 22 digital inputs
- 6 analog and 15 digital outputs
- Ultra wide range power supply from 24 – 230 V AC
- USB connector for easy software upload and datalogging

- Ethernet with Web server feature and several IP protocols
- Remote access to data through CANbus connection for additional display and keyboard
- RTC clock for managing weekly time programs and data logging information with supercapacitor as temporary backup power
- Up to two Modbus RS485 opto-isolated serial interface
- Available with and without graphic LCD display
- Dimensions 16 DIN modules

### Approvals

**CE mark:**

This product is designed to comply with the following EU standards:

- Low voltage directive LVD 2014/35/EU:
  - EN60730-1: 2011 (Automatic electrical control for household and similar use. General requirements)
  - EN60730-2-9: 2010 (Particular Requirements for Temperature Sensing Controls)
- Electromagnetic compatibility EMC directive 2014/30/EU:
  - EN 61000-6-3: 2007 +A1: 2011 (Emission standard for residential, commercial and light-industrial environments)
  - EN 61000-6-2: 2005 (Immunity for industrial environments)
- RoHS directive 2011/65/EU and 2015/863/EU:
  - EN50581: 2012

**UL approval:**

- UL file E31024

### Product part numbers

DESCRIPTION	CODE NO.
MCX15B2, RS485, S	080G0327
MCX15B2, LCD, RS485, S	080G0328
MCX20B2, 2xRS485, I (12 pieces)	080G0329
MCX20B2, LCD, 2xRS485, S	080G0330
MCX20B2, LCD, 2xRS485, I (12 pieces)	080G0331
MCX20B2, LCD, 4 SSR, 2xRS485, S	080G0332

*Note: single pack codes (S) include standard kit connectors, industrial pack codes (I) don't include standard kit connectors*

# Programmable control

## MCX15B2/MCX20B2

### Dimensions

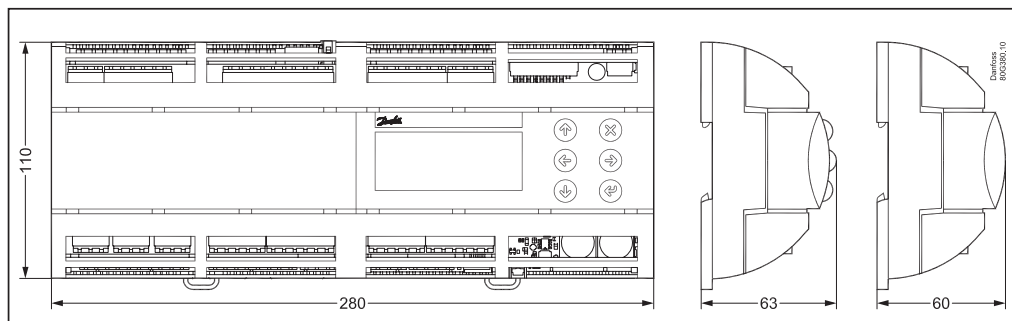

### Technical data

	MCX15B2	MCX20B2
<b>ANALOG INPUTS</b>		
NTC, PT1000, 0/1 V, 0/5 V, 0/10V selectable via software	4	6
Universal NTC, PT1000, 0/1 V, 0/5 V, 0/10 V, ON/OFF, 0/20 mA, 4/20 mA, selectable via software	6	10
<b>Total number</b>	<b>10</b>	<b>16</b>
<b>DIGITAL INPUTS</b>		
Voltage free contacts or 24 V AC	18	18
24 V AC optoinsulated	4	4
230 V AC optoinsulated	4	4
<b>Total number</b>	<b>22</b>	<b>22</b>
<b>ANALOG OUTPUTS</b>		
0/10 V, PWM, PPM selectable via software	2	2
0/10 V DC optoinsulated	6	6
<b>Total number</b>	<b>6</b>	<b>6</b>
<b>DIGITAL OUTPUTS</b>		
SPDT relay 16 A (changeover contacts)	2	2
SPST relay 5 A (normally open contacts)	13	18
<b>Total number</b>	<b>15</b>	<b>20</b>
<b>OTHERS</b>		
Power supply 21 – 265 V AC, 50/60 Hz, 40 – 230 V DC	•	•
Connection for programming key	•	•
Connection for remote display and keyboard	•	•
Buzzer	–	–
CANbus	•	•
RTC clock	•	•
Modbus RS485 serial interface	1	2
Ethernet /Websserver and Modbus TCP	1	1
USB host	•	•
Dimensions (DIN modules)	16	16
Mounting	DIN rail	DIN

# User interface module

## MMIGRS2

### Functional description

MMIGRS2 is MCX's family remote interface. It's fitted with a graphic display that allows a complete customization of the user interface. The connection with every unit of the MCX range is made through the CANbus network. All the information about the user interface is loaded inside the MCX controller; that's why there is no need of programming the MMIGRS2 interface. MMIGRS2 is powered externally or from the controller which it is connected to and automatically shows its user interface.



### Features

- Full graphic LCD display, 128 x 64 dots resolution
- Easy connection to MCX CANbus network through telephone plug and CAN connector
- No need to be programmed: information about user interface is loaded from the MCX controller
- Powered by the MCX which it is connected to
- Dimensions 88 x 150 mm
- Panel and wall mounting
- IP64 protection rating on panel version

### Approvals

- CE mark:**  
 This product is designed to comply with the following EU standards:
- Electromagnetic compatibility EMC directive 2014/30/EU:
    - EN 61000-6-4: 2007 +A1: 2011 (Emissions standard for industrial environments)
    - EN 61000-6-2: 2005 (Immunity for industrial environments)
  - RoHS directive 2011/65/EU and 2015/863/EU:
    - EN50581: 2012
- UL approval:**
- UL file E31024

### Product part numbers

DESCRIPTION	CODE NO.
MMIGRS2, REMOTE DISPLAY, PANEL, S	080G0294
MMIGRS2, REMOTE DISPLAY, WALL, S	080G0295
MMIGRS2, REMOTE DISPLAY, PANEL, I	080G0297

**Note:** both single pack codes (S) and industrial pack codes (I) include standard kit connector

# User interface module

## MMIGRS2

### Dimensions

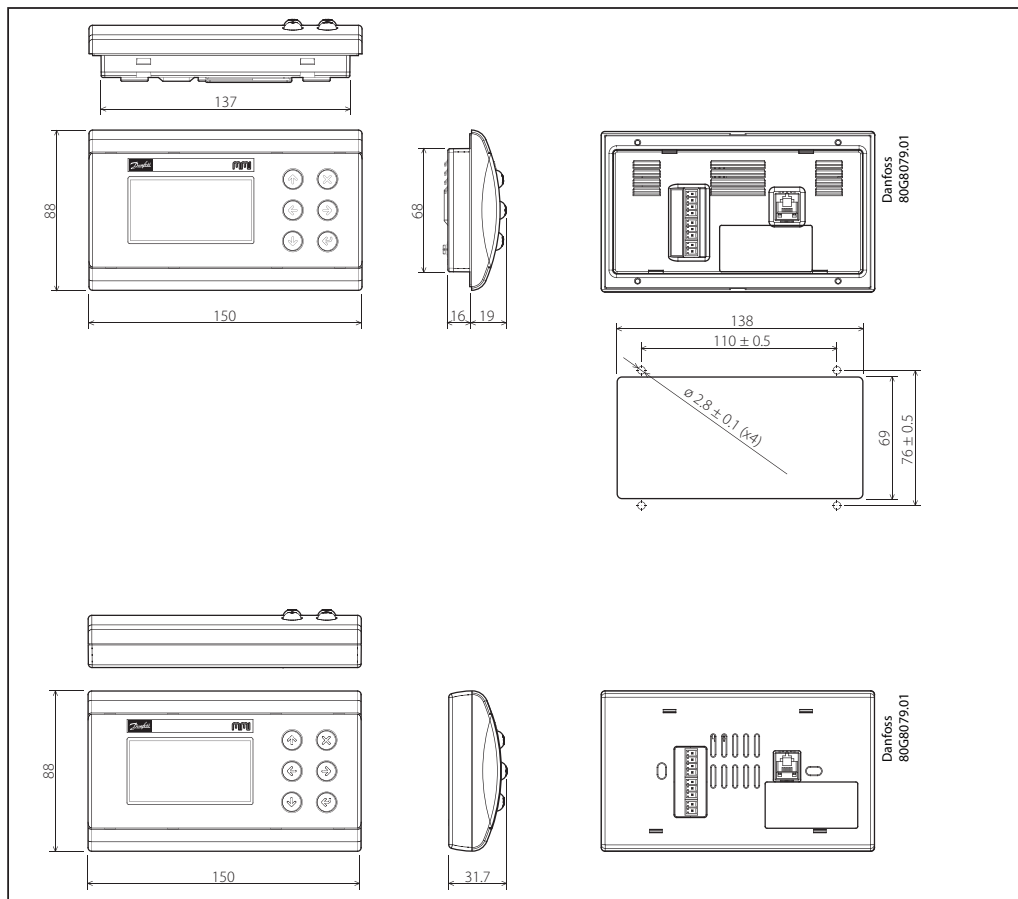

### Technical data

TECHNICAL DATA	MMIGRS2
Power supply	<ul style="list-style-type: none"> <li>- from the MCX through the RJ12 telephone connector</li> <li>- 12/30 V DC (separate power supply is recommended)</li> <li>- 24 V AC +10% / -15% (separate power supply is recommended)</li> <li>- maximum power consumption: 1.5 W</li> </ul>
<b>USER INTERFACE</b>	
Display	<ul style="list-style-type: none"> <li>- graphical LCD blue transmissive</li> <li>- white LED backlight with adjustable brightness via software</li> <li>- display format 128 x 64 dots</li> <li>- active visible area 66.5 x 33.2 mm</li> <li>- contrast adjustable via software</li> </ul>
Keyboard	<ul style="list-style-type: none"> <li>- 6 white LED backlight keys individually managed via software</li> <li>- function key configurable via the application software</li> </ul>
Mounting	Based on the version: <ul style="list-style-type: none"> <li>- panel mounting, see the drilling template in figure using the screws supplied in the packaging</li> <li>- wall mounting on a standard 3 modules box</li> </ul>
<b>OTHERS</b>	
CANbus	•
Buzzer	•
RTC clock	
Degree of protection	<ul style="list-style-type: none"> <li>- IP64 ~ NEMA3R (panel version)</li> <li>- IP40 (wall version)</li> </ul>

# User interface module

## MMIGRS2CC

### Functional description

MMIGRS2CC close control is MCX's family remote interface. It's fitted with a graphic display that allows a complete customization of the user interface.

The connection with every unit of the MCX range is made through the CANbus network.

All the information about the user interface is loaded inside the MCX controller; that's why there is no need of programming the MMIGRS2CC interface.

MMIGRS2CC is powered externally or from the controller which it is connected to and automatically shows its user interface.



### Features

- Full graphic LCD display, 128 x 64 dots resolution
- Easy connection to MCX CANbus network through telephone plug and CAN connector
- No need to be programmed: information about user interface is loaded from the MCX controller
- Powered by the MCX which it is connected to
- Dimensions 88 x 150 mm
- Panel and wall mounting
- IP64 protection rating on panel version
- 2 dedicated keys for easy access to alarm and ON/OFF functions
- 3 coloured back lighted keys: red, orange and green

### Approvals

#### CE mark:

This product is designed to comply with the following EU standards:

- Electromagnetic compatibility EMC directive 2014/30/EU:
  - EN 61000-6-4: 2007 +A1: 2011 (Emissions standard for industrial environments)
  - EN 61000-6-2: 2005 (Immunity for industrial environments)
- RoHS directive 2011/65/EU and 2015/863/EU:
  - EN50581: 2012

#### UL approval:

- UL file E31024

### Product part numbers

DESCRIPTION	CODE NO.
MMIGRS2, CLOSE CONTROL, WALL, S	080G0299
MMIGRS2, CLOSE CONTROL, PANEL, I	080G0298

**Note:** both single pack codes (S) and industrial pack codes (I) include standard kit connector

# User interface module

## MMIGRS2CC

### Dimensions

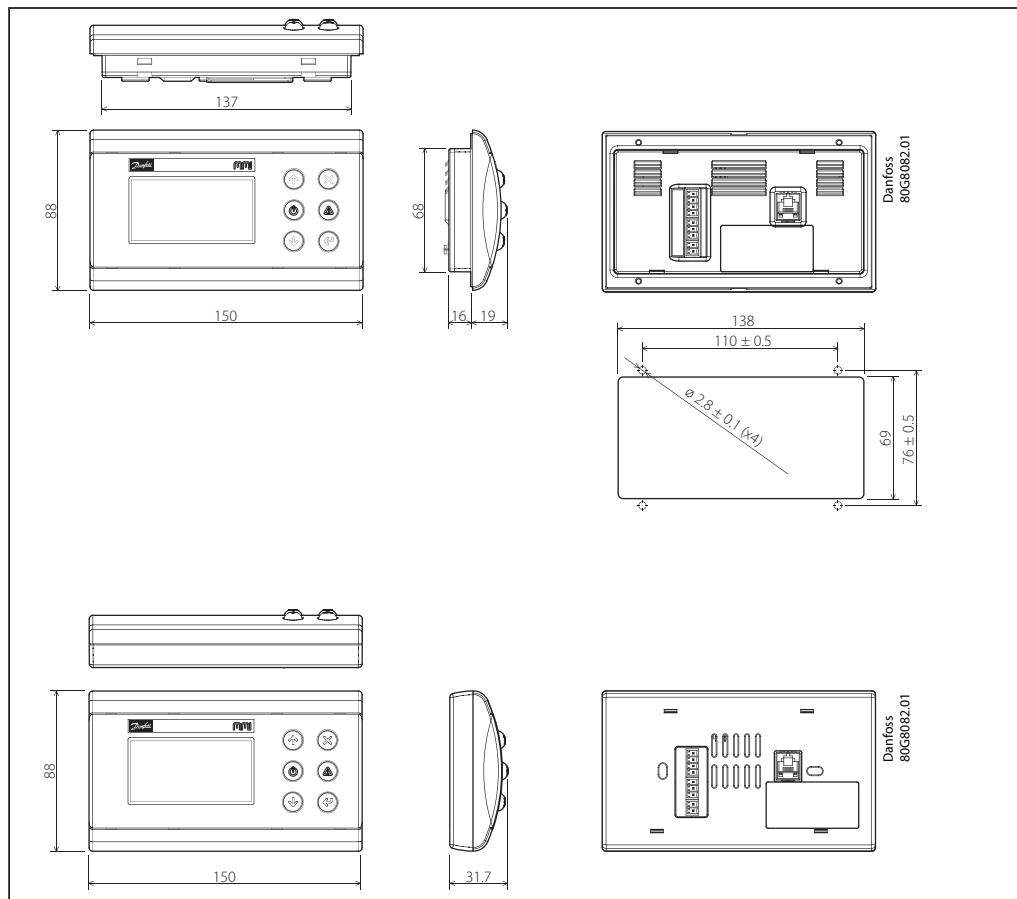

### Technical data

TECHNICAL DATA	MMIGRS2
Power supply	- from the MCX through the RJ12 telephone connector - 12/30 V DC (separate power supply is recommended) - 24 V AC +10% – -15% (separate power supply is recommended) - maximum power consumption: 1.5 W
<b>USER INTERFACE</b>	
Display	- graphical LCD blue transmissive - white LED backlight with adjustable brightness via software - display format 128 x 64 dots - active visible area 66.5 x 33.2 mm - contrast adjustable via software
Keyboard	- 6, of which 3 with respectively green, red, orange LEDs that can be individually managed via software - set by the application software
Mounting	Based on the version: - panel mounting, see the drilling template in figure using the screws supplied in the packaging - wall mounting on a standard 3 modules box
<b>OTHERS</b>	
CANbus	•
Buzzer	•
RTC clock	
Degree of protection	- IP64 (panel version) - IP40 (wall version)

## User interface module

### MMILDS

#### Functional description

MMILDS is MCX's family remote interface. It's fitted with a LED display for displaying data from a MCX or from 2 probes that can be locally connected. The connection with any MCX controller is through the CAN bus network. The power supply can come from controller which it is connected. All the information about the user interface is loaded inside the MCX controller; that's why there is no need of programming the MMILDS interface.



#### Features

- LED display 3-1/2 digit
- Easy connection to MCX CANbus network through wired connector kit
- Connections for 2 external probes
- Powered by the MCX which it is connected to
- Dimensions 84 x 36 mm
- Panel mounting

#### Approvals

##### CE mark:

This product is designed to comply with the following EU standards:

- Electromagnetic compatibility EMC directive 2014/30/EU:
  - EN60730-1: 2011 Automatic electrical control for household and similar use. General requirements (Annex ZD and H)
- RoHS directive 2011/65/EU and 2015/863/EU:
  - EN50581: 2012

#### Product part numbers

DESCRIPTION	CODE NO.
MMILDS, 12 V, LED, CAN, REMOTE DISPLAY, PANEL, I	080G0233

**Note:** single pack codes (S) don't include standard kit connectors, industrial pack codes (I) don't include standard kit connectors



# User interface module

## MMILDS

### Dimensions

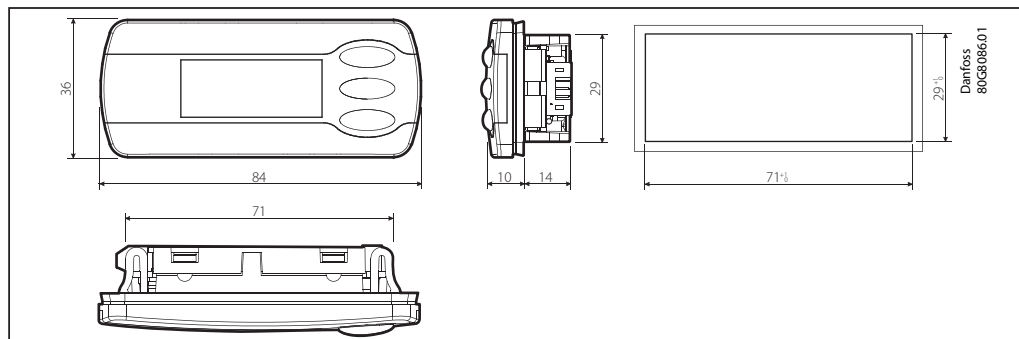

### Technical data

TECHNICAL DATA	MMILDS
Analog input	- AI1: 0/20 mA, 4/20 mA, 0/5 V, 0/1 V, selectable via software - AI2: NTC, default 10 K $\Omega$ at 25 °C, selectable via software
Power supply	- from the MCX through the RJ12 telephone connector - maximum power consumption: 1.5 W
<b>USER INTERFACE</b>	
Display	LED 3-1/2 digit
Keyboard	3 key
Mounting	Panel mounting (see the drilling template in figure)
<b>OTHERS</b>	
CANbus	•
Buzzer	
RTC clock	
Degree of protection	IP65

# Programmable module

## MMIMYK

### Functional description

MMIMYK is the advanced “all in one” device that performs up to three different functions:

- Programming module
- Gateway
- Data logger

It has a bright graphic display and a keyboard that enable to configure the module to run several functions. It has also a slot for MMC card (Multi Media Card) to extend the memory capacity.



### Features

- Full graphic OLED display, 128 x 64 dots resolution
- Easy connection to MCX CANbus network through telephone plug
- MMC card slot for easy software upload and datalogging
- Modbus RS485 serial interface
- Powered by the MCX which it is connected to or the other way round
- Can execute an application like any MCX device
- Dimensions 105 x 72 mm
- Mounting DIN rail or portable

### Approvals

**CE mark:**  
 This product is designed to comply with the following EU standards:

- Electromagnetic compatibility EMC directive 2014/30/EU:
  - EN 61000-6-4: 2007 +A1: 2011 (Emissions standard for industrial environments)
  - EN 61000-6-2: 2005 (Immunity for industrial environments)
- RoHS directive 2011/65/EU and 2015/863/EU:
  - EN50581: 2012

### Product part numbers

DESCRIPTION	CODE NO.
MMIMYK, PC/MCX INTERFACE AND MCX PROGRAMMING, DATA LOGGING, S	080G0073

*Note: single pack codes (S) don't include standard kit connectors*

# Programmable control

## MMIMYK

### Dimensions

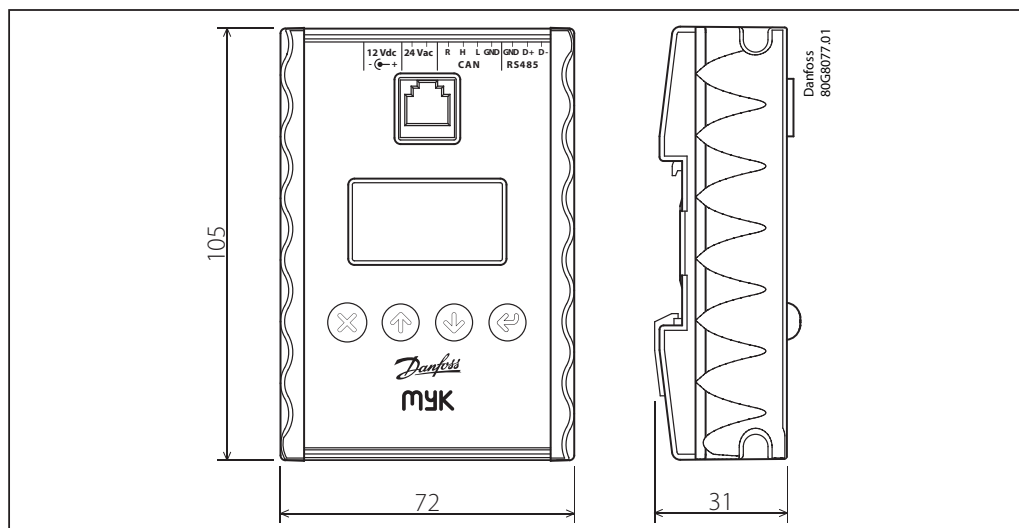

### Technical data

TECHNICAL DATA	MMIMYK
<b>OLED DISPLAY</b>	
Display	Graphic OLED
Format	128 x 64 dots
Active visible area	35 x 17.5 mm
<b>KEYBOARD</b>	
Number of keys	4
Keys function	Set by the application software
<b>MEMORY</b>	
Internal	2 MB
MMC	Expansion slot (Multi Media Card) up to 2 GB

# Accessory - Gateway

## ACCGTW

### Functional description

ACCGTW is a programmable gateway for protocol conversion, that allows the connectivity from the MCX's Modbus to BACnet and LonWorks fieldbus.



### Features

- Configuration file generated by MCXShape tool
- Supports virtual nodes allowing multiple OEM controllers to connect to a single ProtoNode and seen as separate controllers on the various field networks
- BACnet COV support provides fast data communication while reducing the traffic over a BACnet network

### Approval

#### Compliance:

- Lonworks
  - LonMark 3.4 Certified TUV approved to UL-916 EN 60950-1, EN 50491-3 and CSA C22-2 standards
  - RoHS Compliant
  - DNP3 Conformance Tested
  - CE & FCC Approved
- BACnet
  - BACnet Testing Labs (BTL) B-ASC Ver. 12
  - TUV approved to UL-916 EN 60950-1, EN 50491-3 and CSA C22-2 standards
  - RoHS Compliant
  - DNP3 Conformance Tested
  - CE & FCC Approved

### Product part numbers

DESCRIPTION	CODE NO.
ACCGTW, BACnet GATEWAY	080G0269
ACCGTW, Lonworks-FTT-10 GATEWAY	080G0270

## Accessory - Gateway

### ACCGTW

#### Dimensions

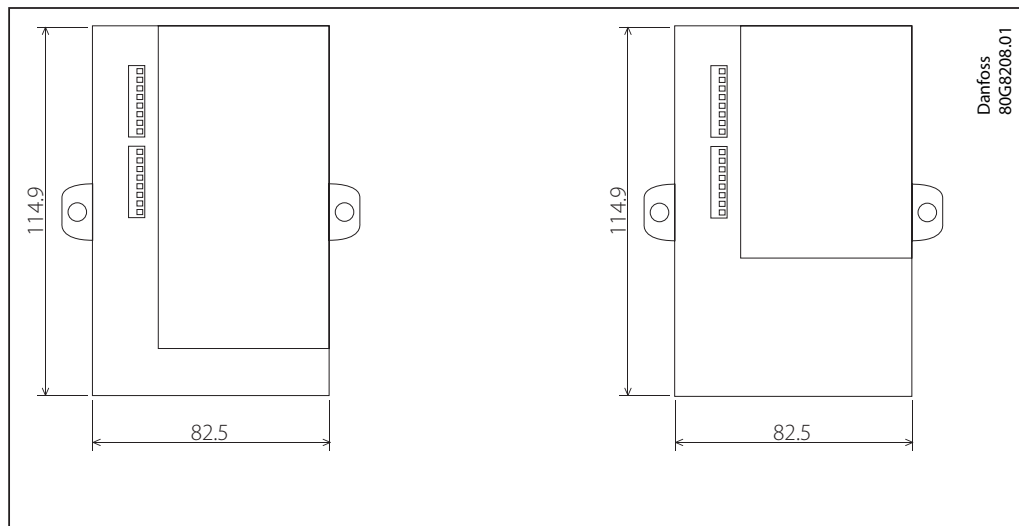

#### Technical data

TECHNICAL DATA	ACCGTW
<b>POWER SUPPLY</b>	
5 V DC or 9 ~ 30 V DC / V AC	
<b>CONNECTIONS</b>	
Ethernet	
RS485	
<b>OTHERS</b>	
Protocols	BACnet MSTP - BACnet IP - Lonworks FTT10
Dimensions (DIN module)	4
Mounting	DIN rail

## Accessory - Speed controller

### ACCSCS

#### Functional description

ACCSCS are designed to regulate the speed of fans and pumps proportionally and continuously. They function as a simple voltage regulator whose command signal 0..10 V or 4..20 mA or PWM comes from an external regulating device. It's possible to connect more than one motor in parallel provided that the maximum input regulating current is less than the controller nominal current.



#### Features

##### Three phase model

- Power 400 V
- Input voltage three phase 400 V AC -15 +10%, 50/60 Hz
- Output voltage 30...99% of supply line
- Command signal 0...10 V, 4..20 mA and PWM 5/10 V
- Aux output supply +10 V aux power (I<sub>max</sub> = 50 mA) for external potentiometer
- Output relay that commutate in case of phase loss or overtemperature

#### Approval

##### CE compliance:

Conforms to Dir. B.T. 2006/95CE, Dir. EMC 89/336-92/31-93/68

#### Product part numbers

DESCRIPTION	CODE NO.
ACCSCS, THREE PHASE REG. 400 V AC, 8A	080G0217
ACCSCS, THREE PHASE REG. 400 V AC, 12A	080G0218
ACCSCS, THREE PHASE REG. 400 V AC, 20A	080G0219
ACCSCS, THREE PHASE REG. 400 V AC, 28A	080G0220
ACCSCS, THREE PHASE REG. 400 V AC, 8A, I	080G0279

## Accessory - Speed controller

### ACCSCS

#### Dimensions

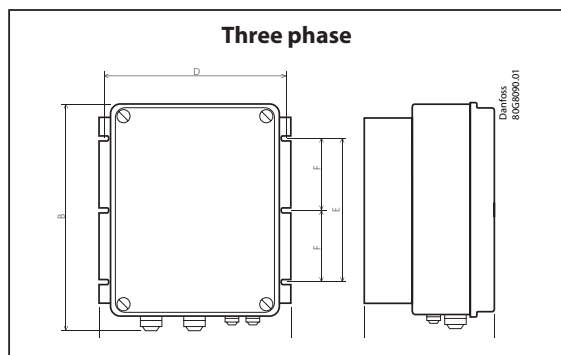

#### Dimensions table

CODE NO.	A	B	C	D	E	F	Weight
	[mm]	[mm]	[mm]	[mm]	[mm]	[mm]	[kg]
<b>080G0217</b>	230	165	150	215	80	-	2.5
<b>080G0218</b>	230	265	165	215	170	-	4
<b>080G0219</b>	230	265	230	215	170	-	4.8
<b>080G0220</b>	340	270	235	322	165	-	7
<b>080G0279</b>	230	165	150	215	80	-	2.5

#### Technical data three phase

FEATURES	080G0217	080G0218	080G0219	080G0220
Power - 400 V AC	5.5 KVA	8 KVA	13 KVA	19 KVA
Current nom (Arms)	8 A	12 A	20 A	28 A
Input voltage	Three phase 400 V AC -15 +10%, 50/60 Hz			
Output voltage	30...99% of supply line			
Command signal	Signal 0...10 V, 4...20 mA, PWM 5/10 V and Modbus			
Analog output	+10 V (max load 50 mA)			
Digital output	Emergency relay 1 A-250 V AC / 3 A-30 V DC			
Protections	Class II at the input terminal block (4 K V) Class I as regards the accessible parts Phase lost, overheating (the regulator restores automatical)			
Operating temperature	-10 °C...+50 °C (-20 °C when the power is maintained)			
Max heat sink temperature	75 °C			
Storage temperature	-20 °C...+80 °C			
Protection degree	Self-extinguishing plastic covering IP55			
Dimensions (mm) - LxHxP	230 x 165 x 150	230 x 265 x 165	230 x 265 x 230	340 x 270 x 235

## Accessory - Transformers

### ACCTRD

**Functional description**

ACCTRD are safety transformers from 230 V AC to 24 V AC protected against short circuit and fully packed into epossidic resin for DIN rail mounting.



**Approval**

**Compliance:**

- UNI EN ISO 9001:2000
- IMQ
- VDE
- ENEC
- UL
- RoHS 2002/95/CE

**Product part numbers**

DESCRIPTION	CODE NO.
ACCTRD, EMERGENCY TRANSFORMER, 230VAC/24VAC, 12VA, DIN MOUNTING	080G0223
ACCTRD, EMERGENCY TRANSFORMER, 230VAC/24VAC, 22VA, DIN MOUNTING	080G0225
ACCTRD, EMERGENCY TRANSFORMER, 230VAC/24VAC, 35VA, DIN MOUNTING	080G0226



## Accessory - Transformers

### ACCTR

#### Dimensions

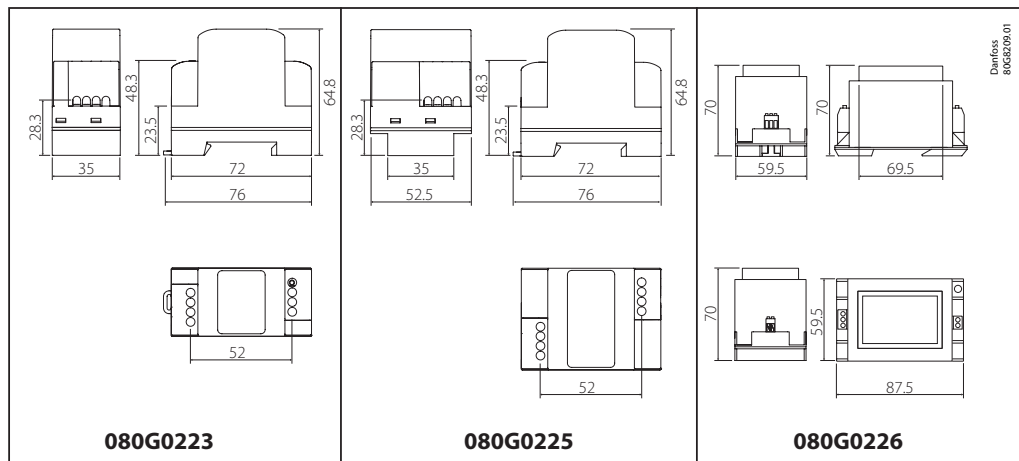

#### Technical data

TECHNICAL DATA	ACCTR
<b>POWER SUPPLY</b>	
Primary voltage	230 V AC
Secondary voltage	24 – 30 V AC
<b>OTHERS</b>	
Internal protection device	PTC thermistor
Mounting	DIN rail

# Accessory - Probe



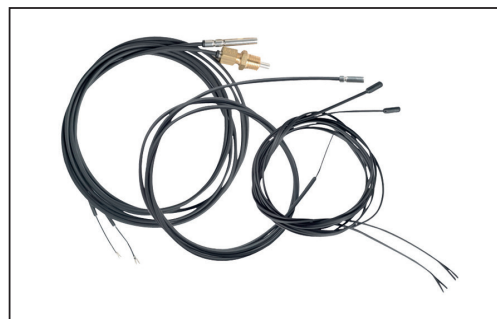

## ACCPBT

### Functional description

The ACCPBT temperature probes series come to cover all needs of temperature monitoring, for low and high temperature applications. It includes NTC probes with IP67 and IP68. When more accuracy is required, then PT1000 probes IP68 are available.



### Dimensions

<p>080G0202 - ACCPBT, NTC TEMPERATURE PROBE, IP68 6X20, 10 KΩ @ 25°C, 3m CABLE</p>  <p style="text-align: right;">Danfoss 80G0281.01</p>
<p>080G0205 - ACCPBT, NTC TEMPERATURE PROBE, IP68 6X40, 10 KΩ @ 25°C, 1.5m CABLE 080G0206 - ACCPBT, NTC TEMPERATURE PROBE, IP68 6X40, 10 KΩ @ 25°C, 3m CABLE 080G0207 - ACCPBT, NTC TEMPERATURE PROBE, IP68 6X40, 10 KΩ @ 25°C, 6m CABLE</p>  <p style="text-align: right;">Danfoss 80G0282.01</p>
<p>080G0209 - ACCPBT, PT1000 TEMPERATURE PROBE, IP68 6X40, 1.5m CABLE 080G0210 - ACCPBT, PT1000 TEMPERATURE PROBE, IP68 6X40, 6m CABLE</p>  <p style="text-align: right;">Danfoss 80G0284.01</p>
<p>080G0211 - ACCPBT, PT1000 TEMPERATURE PROBE, IP44 5X40, 0 +550°C, 1.5m CABLE</p>  <p style="text-align: right;">Danfoss 80G0285.01</p>
<p>080G0212 - ACCPBT, NTC TEMPERATURE PROBE, IP67 6X40, -50+200°C, 100 KΩ @ 25°C, 1.5m CABLE</p>  <p style="text-align: right;">Danfoss 80G0283.01</p>

### Product part numbers

DESCRIPTION	CODE NO.
ACCPBT, NTC TEMPERATURE PROBE, IP68 6X20, 3 m CABLE	080G0202
ACCPBT, NTC TEMPERATURE PROBE, IP68 6X40, 1.5 m CABLE	080G0205
ACCPBT, NTC TEMPERATURE PROBE, IP68 6X40, 3 m CABLE	080G0206
ACCPBT, NTC TEMPERATURE PROBE, IP68 6X40, 6 m CABLE	080G0207
ACCPBT, PT1000 TEMPERATURE PROBE, IP68 6X40, 1.5 m CABLE	080G0209
ACCPBT, PT1000 TEMPERATURE PROBE, IP68 6X40, 6 m CABLE	080G0210
ACCPBT, PT1000 TEMPERATURE PROBE, IP44 5X40, 1.5 m CABLE, 0 +550 °C	080G0211
ACCPBT, NTC TEMPERATURE PROBE, IP67 6X40, -50+200 °C, 100KΩ @ 25 °C	080G0212

## Accessory - Cable

### ACCCBI

**Functional description**

The ACCCBI connecting cables can provide all different needs for connection between MCX controller and MMI user interface.

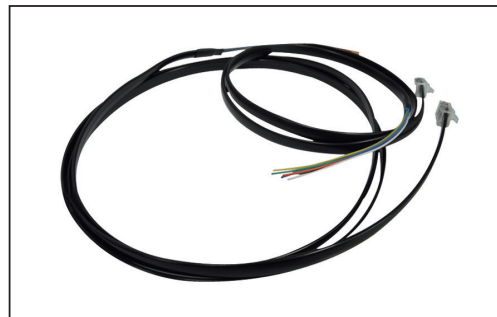

**Product part numbers**

DESCRIPTION	CODE NO.
ACCCBI, TELEPHONE CABLE USER INTERFACE CONNECTOR, 1.5 m CABLE	080G0075
ACCCBI, TELEPHONE CABLE USER INTERFACE CONNECTOR, 3 m CABLE	080G0076
ACCCBI, MMILDS CABLE RJ12/JST PH, 2 m CABLE	080G0239

## Accessory - Kit connectors

### ACCCNX

#### Functional description

ACCCNX kit connectors are available for any MCX



#### Product part numbers

DESCRIPTION	CODE NO.
ACCCNX, WIRED CONNECTORS KIT FOR MCX06C, 1 m CABLE	080G0081
ACCCNX, WIRED CONNECTORS KIT FOR MCX06C, 2 m CABLE	080G0082
ACCCNX, MCX06C CONNECTORS KIT	080G0175
ACCCNX, MCX06D CONNECTORS KIT	080G0179
ACCCNX, MCX08M CONNECTORS KIT	080G0180
ACCCNX, MCX20B2 CONNECTORS KIT	080G0404