

Installation guide

**Colibri® Electric Expansion Valves**

Type ETS 12C, ETS 24C, ETS 25C, ETS 50C, ETS 100C

**Colibri® Electric Regulating Valves**

Type KVS 2C, KVS 3C KVS 5C



English

034R9806

034R9806

**Refrigerants :** R410A, R404A, R507, R134a, R407A, R407B, R407C, R407F, R32, R290, R1234ze, R1234yf, R449A, R449B, R452A, R1270, R600, R600a, R22, R23, R227, R417A, R444B, R447A, R448A, R454B, R422A, R422D, R427A, R502, R513A, R413A, R438A, R450A, R455B, R454C, R454A, R452B and \*L40

\*R-number allocation by ASHRAE is pending

**Allowable ambient temperature:**

Min. -40 °C / -40 °F

Max. 70 °C / 158 °F

**Fluid temperature:**

Min. -40 °C / -40 °F

Max. 70 °C / 158 °F

**Max. working pressure:**

50 bar(g) / 725 psi(g)

**Stepper motor type:**

Bipolar

**Phase current:**

800 mA peak /

600 mA RMS

**Coil resistance:**

10 Ω (20 °C / 68 °F)

**Total steps:**

600 full steps



**Do not connect directly to AC/DC power source.  
Connect valve to appropriate controller/driver only.**



ETS / KVS Colibri® valves are delivered in open position, ready for brazing.  
An AST -g service driver is available for manual operation / service of ETS / KVS Colibri® valves.

**Flow direction**

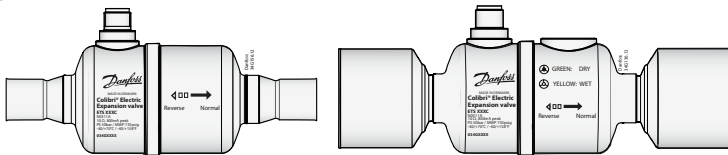

Bi-flow

Reverse flow ← □ □ → Normal flow

(Using sight glass for flash gas detection - ETS 25C to ETS 100C)

KVS Colibri® valves have no sight glass integrated

**Application ETS Colibri®**

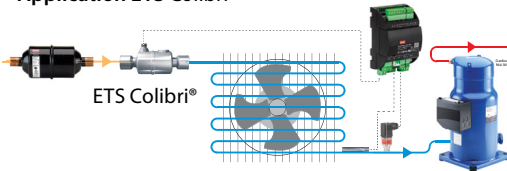

ETS Colibri®

Place the valve close to the evaporator.

It is recommended to use Danfoss filter drier before the expansion valve or a strainer for particles of 150 micron or smaller.

**Application KVS Colibri®**

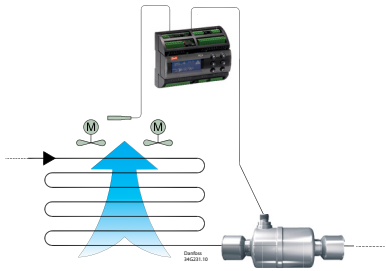

KVS Colibri®



Installation guide

**Colibri® Electric Expansion Valves**

Type ETS 12C, ETS 24C, ETS 25C, ETS 50C, ETS 100C

**Colibri® Electric Regulating Valves**

Type KVS 2C, KVS 3C KVS 5C



Deutsch, French

034R9806

034R9806

**Kältemittel / Fluids:** R410A, R404A, R507, R134a, R407A, R407B, R407C, R407F, R32, R290, R1234ze, R1234yf, R449A, R449B, R452A, R1270, R600, R600a, R22, R23, R227, R417A, R444B, R447A, R448A, R454B, R422A, R422D, R427A, R502, R513A, R413A, R438A, R450A, R455B, R454C, R454A, R452B and \*L40

\*R-number allocation by ASHRAE is pending.

<b>Umgebungstemperatur:</b> <b>Température ambiante:</b> Min. -40 °C, Max. 70 °C	<b>Kältemitteltemperatur:</b> <b>Température du fluide:</b> Min. -40 °C, Max. 70 °C	<b>Max. Betriebsdruck:</b> <b>Pression de service max.:</b> 50 bar(g)	
<b>Schrittmotortyp:</b> <b>Type de moteur pas à pas:</b> Bipolar	<b>Stromaufnahme:</b> <b>Courant de phase:</b> 800 mA Peak (600 mA RMS)	<b>Widerstand, Spule:</b> <b>Résistance de la bobine:</b> 10 Ω (20 °C)	<b>Max. Schritte:</b> <b>Nombre de pas total:</b> 600 full steps



Bitte das ETS / KVS Colibri® nicht direkt mit einer Spannungsquelle verbinden. Schließen Sie das Ventil nur an geeignete Regler/ Steuergeräte an.

**Ne pas raccorder directement le moteur à une alimentation AC / DC. Raccorder la vanne au régulateur approprié.**



Ventile werden in offener Position geliefert, bereit zum Löten. Für den manuellen Betrieb / Wartung von ETS / KVS Colibri® Ventilen, ist ein AST -g- Servicemodul als Zubehör erhältlich.

Les vannes sont livrées en position ouverte, prêtes pour le brasage. Un pilote d'entretien AST-g est disponible pour manœuvrer les vannes ETS C / KVS Colibri®.

**Durchflussrichtung / Sens d'écoulement**

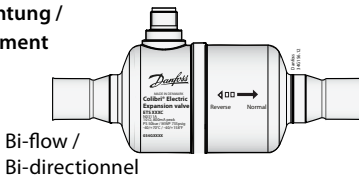

Bi-flow / Bi-directionnel



Umgekehrt Durchfluss / Direction inverse



Normaler Durchfluss (ETS 25C und ETS 100C mit Schauglas für Flashgas Erkennung) Sens normal (ETS 25C pour ETS 100C - à l'aide du voyant de détection de gaz flash) KVS Colibri® haben kein Schauglas Les détendeurs KVS Colibri® n'ont pas de voyant intégré

**Anwendung / Application ETS Colibri®**

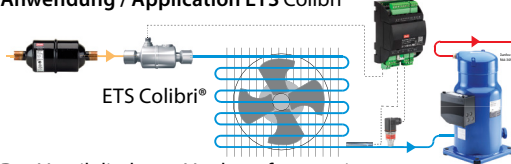

Das Ventil direkt am Verdampfer montieren. Placez la vanne près de l'évaporateur. Es wird empfohlen Filtertrockner von Danfoss vor dem Expansionsventil oder einen Filter für Partikel von 150 µm oder kleiner zu verwenden. Il est recommandé d'utiliser un filtre déshydrateur Danfoss avant la vanne de détente, ou un filtre à particules de 150 microns ou moins.

**Anwendung / Application KVS Colibri®**

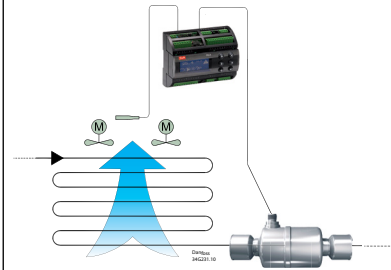

KVS Colibri®

### Einbau- / Montage

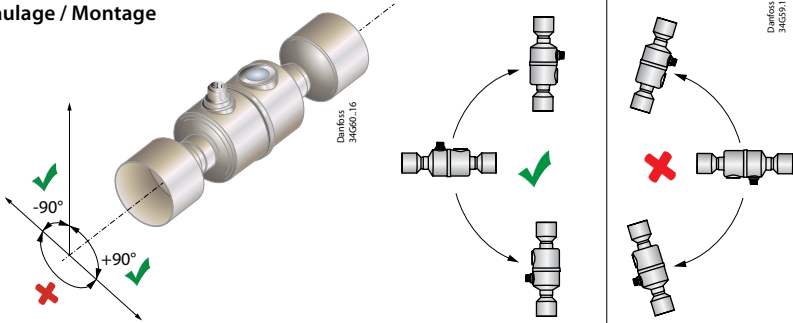

### Löten / Soudure

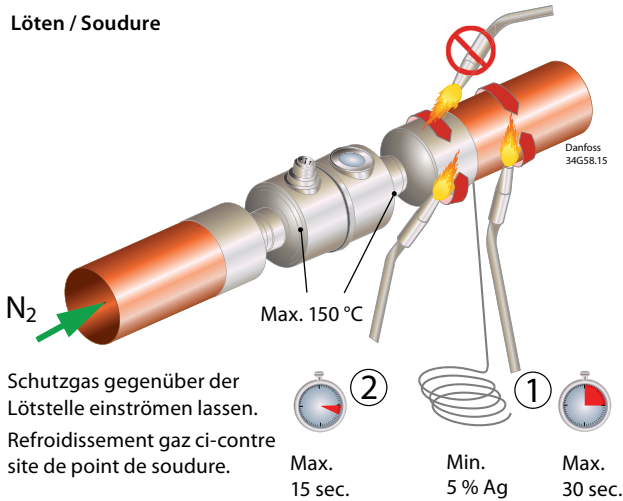

### Empfehlung / Recommendation

Anschluss Raccord	Brenndüse Buse de brasage
1/2 inch	2 mm 1/16 inch
5/8 inch	↕
7/8 inch	↕
1 1/8 inch	9 mm 3/8 inch
1 3/8 inch	
1 5/8 inch	

### M12 Connection / M12 Raccordement

Wicklungswiderstand prüfen.  
Vérification de la résistance de  
la bobine du moteur.

Wicklung A = Wicklung B = 10 Ω (20 °C)  
Bobine A = Bobine B = 10 Ω (20 °C)

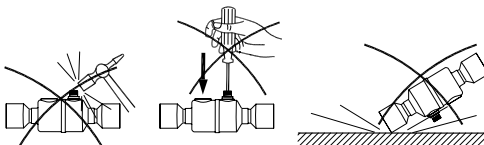
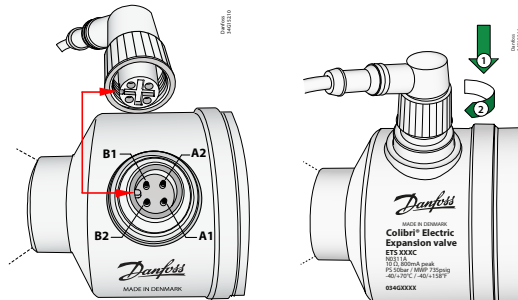

Installation  
Video  
Installation  
vidéo



Installation guide

**Colibri® Electric Expansion Valves**

Type ETS 12C, ETS 24C, ETS 25C, ETS 50C, ETS 100C

**Colibri® Electric Regulating Valves**

Type KVS 2C, KVS 3C KVS 5C



español, 汉语

034R9806

034R9806

**Refrigerantes / 制冷剂适用:** R410A, R404A, R507, R134a, R407A, R407B, R407C, R407F, R32, R290, R1234ze, R1234yf, R449A, R449B, R452A, R1270, R600, R600a, R22, R23, R227, R417A, R444B, R447A, R448A, R454B, R422A, R422D, R427A, R502, R513A, R413A, R438A, R450A, R455B, R454C, R454A, R452B and \*L40

\*R-number allocation by ASHRAE is pending

<b>Temperatura ambiente permisible:</b> 允许运行的环境温度: Min. -40 °C / Max. 70 °C		<b>Temperatura líquido:</b> 流体温度: Min. -40 °C / Max. 70 °C		<b>Presión de trabajo máx.:</b> 最大工作压力: 50 bar(g)	
<b>Tipo de motor a pasos:</b> 步进电机形式: Bipolar 双极		<b>Intensidad:</b> 相电流: 800 mA Pico/peak (600 mA RMS)		<b>Resistencia:</b> 电阻: 10 Ω (20 °C)	
				<b>Número de pasos total:</b> 总步数: 600 full steps / 600 步	



**No aplicar tensión directamente a la válvula. Conectar la válvula a un controlador/driver adecuado.**

请勿将阀门连接于合适的控制器/驱动器，勿直接与交流或直流电源连接。



Las válvulas se entregan abiertas listas para soldar. Existe un driver de servicio AST-g para la operación manual y servicio de las válvulas ETS / KVS Colibri®.

交付时阀门处于全开状态,再进行焊接一切就绪,准备铜焊。提供AST -g手操器用于ETS/KVS Colibri® 电子膨胀阀的手动操作和维修。

**Dirección del flujo / 流向**

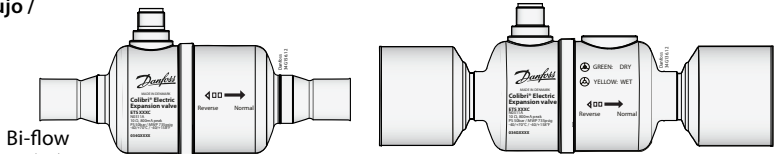

Flujo reversible 反向流动方向

Flujo normal (ETS 25C a ETS 100C incorpora un visor de líquido para detector flash-gas) 正常流动方向 (视镜, 用于闪发气体检测 - ETS 25C 和 ETS 100C)  
 Las válvulas KVS Colibri® no tienen visor integrado KVS Colibri® 电子膨胀阀没有集成观察镜

**Aplicación / 应用 ETS Colibri®**

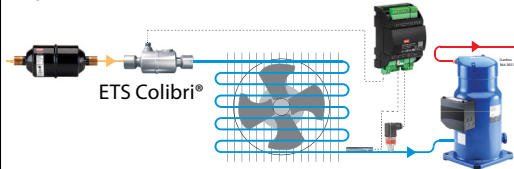

Colocar la válvula próxima al evaporador. 阀关闭位置, 靠近蒸发器侧

Se recomienda utilizar un filtro deshidratador Danfoss antes de la válvula de expansión o un filtro para partículas de 150 micras o menores.

建议在膨胀阀前使用丹佛斯干燥过滤器或使用过滤目数小于等于150微米的过滤网

**Aplicación / 应用 KVS Colibri®**

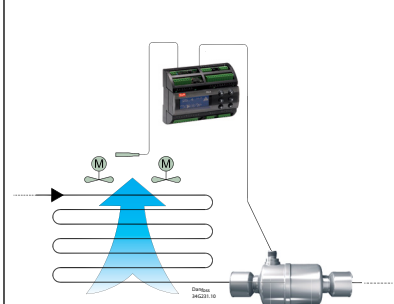

KVS Colibri®

### Instalación / 安装

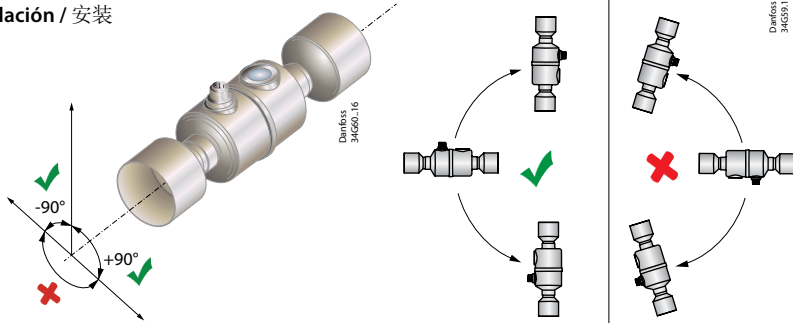

Danfoss  
34G50.11

### Soldadura / 焊接

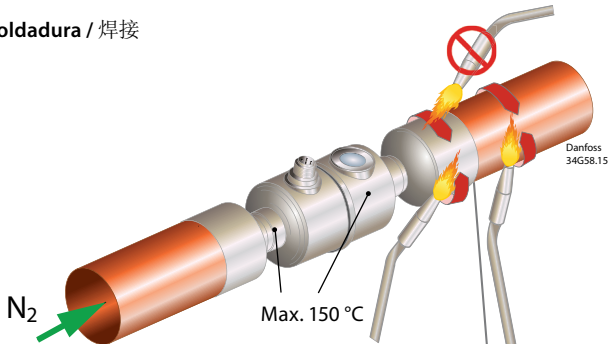

Recomendación/  
推荐

Conexión  
连接

Boquilla soplete  
钎焊嘴

1/2 inch  
5/8 inch  
7/8 inch  
1 1/8 inch  
1 3/8 inch  
1 5/8 inch

2 mm 1/16 inch  
9 mm 3/8 inch

Corriente de N<sub>2</sub> desde el lado  
opuesto a la soldadura.

气体冷却对面的焊点 (氮气保护)

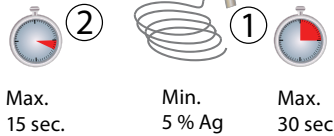

### M12 Conexión / M12 链接

Verificar la resistencia de la bobina  
del motor.

Bobina A = Bobina B = 10 Ω (20 °C)

电机线圈电阻检查

在20°C时, 线圈A=线圈B=10Ω

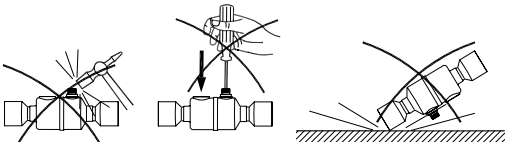
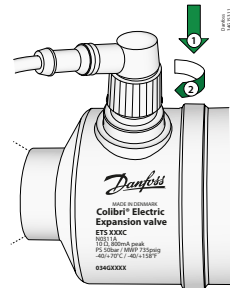
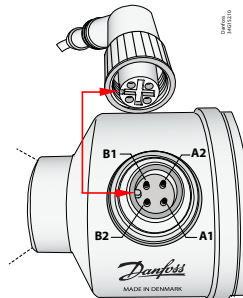

Instalación  
video

安裝  
視頻

