

Distribution blocks

Distribution system



Catalogue 2021

Single-pole distribution blocks

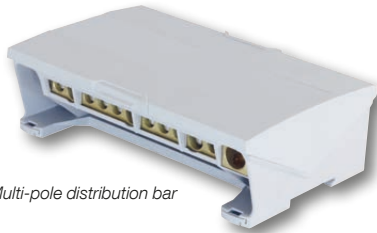

Catalogue 2021

Multi-pole distribution bar

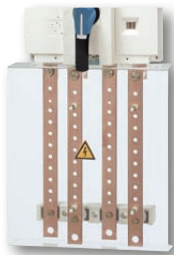

Catalogue 2021

Distribution blocks for SOCOMEC power-switching devices

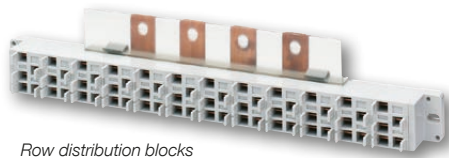

Catalogue 2021

Row distribution blocks

The solution for

- › Electrical distribution



Strong points

- › Extensive range
- › Easy integration
- › IEC and UL range

Compliance with standards

- › IEC 61439-1
- › IEC 60947-7-1
- › UL 1953
- › UL 1059



Function

SOCOMECEC **distribution blocks** make it easy to connect conductors. They are mounted downstream of a load break switch, a changeover switch, a fuse switch or any protection device on the market.

Advantages

Extensive range

This extensive range has the right distribution system for every need:

- 13 single-pole models, 4 multi-pole models and 2 single-block models for copper and aluminium cables for either direct or plug connection
- 1 IP20 row distribution block
- 4 distribution block models for lug connection.

IEC and UL range

Our range of single-pole distribution blocks conforms to IEC and UL standards.

Easy integration

The compact size of the single-pole and multi-pole distributors for direct or plug connection ensures easy integration into the equipment.

Application

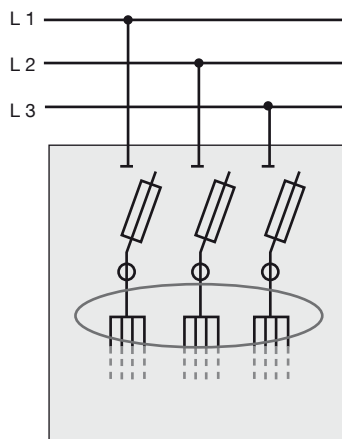

Catalogue 2021

IEC / UL single-pole distribution blocks

General features



Catalogue 2021

- Material: tin-plated aluminium.
- For conductors: aluminium or copper.
- IP20 connection.
- L1, L2, L3, and N markings set by Allen key.
- DIN rail mounted.
- DIN rail attachment clip.
- Backplate mounted.
- Assembly clip for multiple distribution blocks.

References

Type	Rating (A)				References
	IEC		UL		
	Cu cable	Al cable	Cu cable	Al cable	
Type 1	80	63	85	65	54UL 1008
Type 2	125	100	115	90	54UL 1012
Type 3	175	135	175	135	54UL 1017
Type 4	250	200	255	205	54UL 1025
Type 5	415	36	380	310	54UL 1040

Dimensions

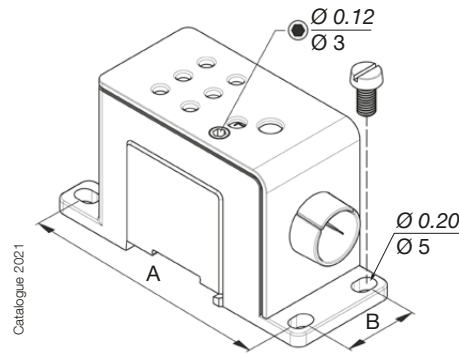

Catalogue 2021

Type	Units	H x W x D	Mounting	
			A	B
Type 1	in	1.93 x 1.417 x 3.524	3.118	0.914
	mm	49 x 36 x 89.5	79.2	23.2
Type 2	in	1.93 x 1.417 x 3.524	3.118	0.914
	mm	49 x 36 x 89.5	79.2	23.2
Type 3	in	2.09 x 1.417 x 3.898	3.492	0.914
	mm	53 x 36 x 99	88.7	23.2
Type 4	in	2.39 x 2.126 x 4.488	4.063	1.622
	mm	60.7 x 54 x 114	103.7	41.2
Type 5	in	2.39 x 2.126 x 4.488	4.063	1.622
	mm	60.7 x 54 x 114	103.7	41.2

Electrical wiring and characteristics

Type	Solid/multi-core cables		Flexible/crimped-plug cables		Voltage according to IEC 60947-7-1		Voltage according to UL 1953		Short-circuit withstand												
	IEC connection	UL connection	IEC connection	UL connection	AC (V)	DC (V)	AC (V)	DC (V)	I _{cw} (kA)	I _{pk} (kA)	SCCR (kA)										
Type 1	1 x 2.5 - 25 mm ²	14 - 3 AWG	1 x 2.5 - 25 mm ²	14 - 3 AWG	1000	1500	1000	1000	3	35	100										
	6 x 2.5 - 10 mm ²	14 - 8 AWG	6 x 2.5 - 6 mm ²	14 - 10 AWG					6	36.1											
Type 2	1 x 2.5 - 50 mm ²	14 - 1 AWG	1 x 2.5 - 35 mm ²	14 - 2 AWG					1000	1500		1000	1000	8.4	40.8	100					
	6 x 2.5 - 25 mm ²	14 - 4 AWG	6 x 2.5 - 16 mm ²	14 - 6 AWG										14.4	47.7						
Type 3	1 x 2.5 - 70 mm ²	14 - 2/0 AWG	1 x 2.5 - 50 mm ²	14 - 1/0 AWG										1000	1500		1000	1000	28.8	57.2	100
	6 x 2.5 - 25 mm ²	14 - 4 AWG	6 x 2.5 - 16 mm ²	14 - 6 AWG																	
Type 4	1 x 35 - 120 mm ²	2 - 250 kcmil	1 x 35 - 95 mm ²	2 - 4/0 AWG	1000	1500	1000	1000												100	
	6 x 2.5 - 35 mm ²	14 - 2 AWG	6 x 2.5 - 25 mm ²	14 - 4 AWG																	
Type 5	1 x 70 - 240 mm ²	2/0 - 500 kcmil	1 x 70 - 185 mm ²	2/0 - 400 kcmil					1000	1500	1000	1000							100		
	6 x 2.5 - 35 mm ²	14 - 8 AWG	6 x 2.5 - 25 mm ²	14 - 4 AWG																	

Distribution blocks

Distribution system

Single-pole IEC/UR distribution blocks

General features

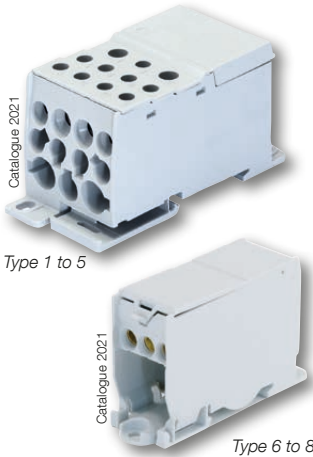

- Material: coated aluminium type 1 to type 5, copper for type 6 to type 8.
- For conductors: Aluminium or copper type 1 to type 5, copper for type 6 to type 8.
- IP20 connection.
- DIN rail mounted.
- Backplate mounted.

References

Type	Rating (A)				References
	IEC		UR		
	Cu cable	Al cable	Cu cable	Al cable	
Type 1	125	100	115	90	5411 1012
Type 2	125	100	115	90	5411 1013
Type 3	175	135	175	135	5411 1017
Type 4	250	200	255	-	5411 1025
Type 5	400	300	-	-	5411 1040
Type 6	125	-	-	-	5411 1011
Type 7	175	-	-	-	5411 1016
Type 8	250	-	-	-	5411 0124
Accessories					References
Connection for type 4					5410 0025
Connection for type 5					5410 0040

Attachments for mounting directly to load break switching device terminal

Dimensions

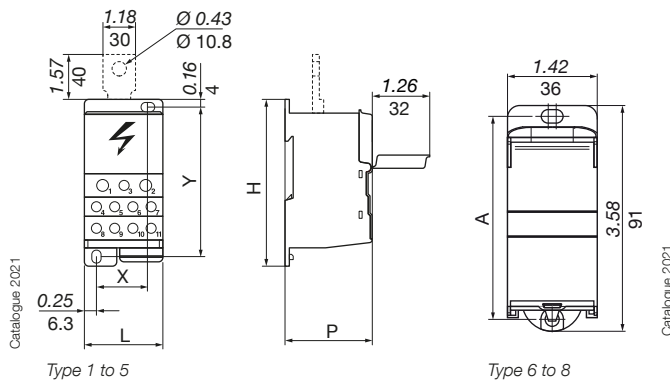

Type 1 to 5

Type 6 to 8

Distribution blocks with direct connection or IP20 jacks that plug into symmetrical DIN rail.

Type	Units	Dimensions H x W x D	Mounting	
			A	B
Type 1	in	2.91 x 1.06 x 1.81	2.44	0.157
	mm	74 x 27 x 46	62	4
Type 2	in	2.80 x 1.77 x 1.69	2.386	0.685
	mm	71 x 45 x 43	60.6	17.4
Type 3	in	2.80 x 1.77 x 1.69	2.386	0.685
	mm	71 x 45 x 43	60.6	17.4
Type 4	in	3.74 x 1.75 x 1.93	3.836	1.165
	mm	95 x 44.5 x 49	86	29.6
Type 5	in	3.74 x 1.75 x 1.93	3.836	1.165
	mm	95 x 44.5 x 49	86	29.6
Type 6	in	3.58 x 1.06 x 2.01	3.22	-
	mm	91 x 27 x 51	81.7	-
Type 7	in	3.58 x 1.42 x 2.01	3.22	-
	mm	91 x 36 x 51	81.7	-
Type 8	in	3.58 x 1.77 x 2.01	3.22	-
	mm	91 x 45 x 51	81.7	-

Electrical wiring and characteristics

Type	Solid/multi-core cables		Flexible/criped-plug cables		Voltage according to IEC 60947-7-1		Voltage according to UL 1059		Short-circuit withstand	
	IEC connection	UL connection	IEC connection	UL connection	AC (V)	DC (V)	AC (V)	DC (V)	I _{cw} (kA)	I _{pk} (kA)
Type 1	1 x 10 - 35 mm ²	1 x 8 - 2 AWG	1 x 10 - 35 mm ²	1 x 8 - 2 AWG	1000	1500	600	600	4.2	30
	1 x 2.5 - 25 mm ²	1 x 14 - 4 AWG	1 x 2.5 - 16 mm ²	1 x 14 - 6 AWG						
	6 x 2.5 - 25 mm ²	6 x 14 - 4 AWG	6 x 2.5 - 16 mm ²	6 x 14 - 6 AWG						
Type 2	1 x 10 - 35 mm ²	1 x 8 - 2 AWG	1 x 10 - 35 mm ²	1 x 8 - 2 AWG						
	10 x 2.5 - 16 mm ²	10 x 14 - 4 AWG	10 x 2.5 - 10 mm ²	10 x 14 - 6 AWG						
	1 x 10 - 70 mm ²	1 x 8 - 2/0 AWG	1 x 10 - 50 mm ²	1 x 8 - 1/0 AWG						
Type 3	10 x 2.5 - 16 mm ²	10 x 14 - 4 AWG	10 x 2.5 - 10 mm ²	10 x 14 - 6 AWG						
	1 x 35 - 120 mm ²	1 x 2 - 250 kcmil	1 x 35 - 95 mm ²	1 x 2 - 4/0 AWG						
	2 x 2.5 - 35 mm ²	2 x 14/2 AWG	2 x 2.5 - 25 mm ²	2 x 14 - 4 AWG						
Type 4	5 x 2.5 - 16 mm ²	5 x 14 - 6 AWG	5 x 2.5 - 16 mm ²	5 x 14 - 6 AWG						
	4 x 2.5 - 10 mm ²	4 x 14 - 8 AWG	4 x 2.5 - 10 mm ²	4 x 14 - 8 AWG						
	1 x 95 - 185 mm ²	-	1 x 95 - 150 mm ²	-						
Type 5	2 x 2.5 - 35 mm ²	-	2 x 2.5 - 25 mm ²	-						
	5 x 2.5 - 16 mm ²	-	5 x 2.5 - 16 mm ²	-						
	4 x 2.5 - 10 mm ²	-	4 x 2.5 - 10 mm ²	-						
Type 6	2 x 10 - 35 mm ²	-	2 x 6 - 25 mm ²	-						
	2 x 2.5 - 25 mm ²	-	2 x 1.5 - 16 mm ²	-						
	6 x 1.5 - 16 mm ²	-	6 x 1.5 - 10 mm ²	-						
Type 7	2 x 25 - 70 mm ²	-	2 x 16 - 50 mm ²	-						
	3 x 2.5 - 25 mm ²	-	3 x 1.5 - 16 mm ²	-						
	8 x 1.5 - 16 mm ²	-	8 x 1.5 - 10 mm ²	-						
Type 8	1 x 35 - 120 mm ²	-	1 x 25 - 95 mm ²	-						
	1 x 1.5 - 50 mm ²	-	1 x 1.5 - 35 mm ²	-						
	4 x 1.5 - 16 mm ²	-	4 x 1.5 - 10 mm ²	-						
	8 x 2.5 - 25 mm ²	-	8 x 2.5 - 16 mm ²	-					14.4	60

Multi-pole distribution blocks with IEC bars

General features



- Material: uncoated brass.
- For conductors: copper.
- DIN rail mounted.
- DIN rail attachment clip.
- Backplate mounted.
- Additional insulated bars.
- Reversible cap.

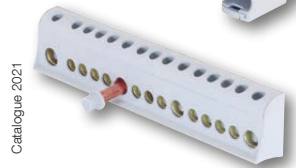

References

Type	Rating (A)	N° of poles	N° of connections	References
Type 1	100	3/4	7	5421 4010
Type 2	125		12	5421 4011
Type 3	125		15	5421 4012
Type 4	160		12	5421 4016
Additional lugs				References
7 connections				5421 1010
12 connections				5421 1012
15 connections				5421 1013

Dimensions

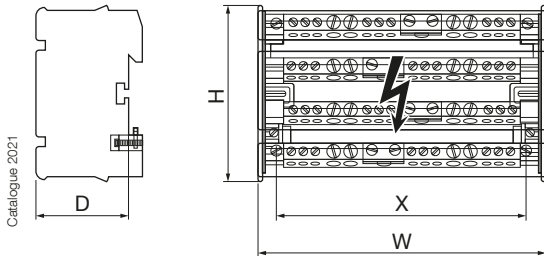

Type	Units	H x W x D	Mounting X
Type 1	in	4.11 x 2.84 x 1.96	2.126
	mm	104.5 x 72.2 x 49.7	54
Type 2	in	4.11 x 5.01 x 1.96	4.291
	mm	104.5 x 127.2 x 49.7	109
Type 3	in	4.11 x 6.90 x 1.96	4.646
	mm	104.5 x 175.2 x 49.7	118
Type 4	in	4.11 x 6.43 x 1.96	4.055
	mm	104.5 x 163.2 x 49.7	103

Electrical wiring and characteristics

Type	Solid/multi-core cables	Flexible/crimped-plug cables	Voltage according to IEC 60947-7-1		Short-circuit withstand	
			AC (V)	DC (V)	I _{cw} (kA)	I _{pk} (kA)
Type 1	2 x 2.5 / 25 mm ²	2 x 1.5 / 16 mm ²	690	1000	3	24
	5 x 1.5 / 16 mm ²	5 x 1.5 / 10 mm ²				
Type 2	1 x 10 / 35 mm ²	1 x 4 / 25 mm ²			4.2	26
	7 x 2.5 / 25 mm ²	7 x 1.5 / 16 mm ²				
Type 3	4 x 1.5 / 16 mm ²	4 x 1.5 / 10 mm ²			4.2	28
	1 x 10 / 35 mm ²	1 x 6 / 35 mm ²				
Type 4	3 x 6 / 35 mm ²	3 x 4 / 25 mm ²			8.4	36
	11 x 1.5 / 16 mm ²	11 x 1.5 / 10 mm ²				
Type 4	1 x 25 / 70 mm ²	1 x 16 / 50 mm ²	8.4	36		
	3 x 10 / 35 mm ²	3 x 4 / 25 mm ²				
	8 x 2.5 / 25 mm ²	8 x 1.5 / 16 mm ²				

Earthing lug

References

Mounting by	N° of outgoing circuits per section (mm ²)	Material	L (mm)	To be ordered in multiples	Reference
2x M4 screws	10 x 16 + 2 x 35	Brass	120	10	5414 0120
2x M6 screws	41 x 16 + 2 x 35	Brass	470	10	5414 0470



Distribution blocks

Distribution system

IEC / UR single-block multi-pole distribution blocks

General features



Catalogue 2021

Single-block multi-pole distribution block
175 A 3 P

- Material: uncoated brass for 125 A, tin-plated copper for 175 A.
- For conductors: aluminium or copper (175 only).
- IP20 connection.
- DIN rail mounted.

References

Rating (A)	N° of poles	Rating (A)				References
		IEC		UL		
		Cu cable	Al cable	Cu cable	Al cable	
125	4	125	-	-	-	5411 4112
175	3	175	135	175	135	5411 3017

Dimensions

Rating (A)	Units	H x W x D	Mounting	
			A	B
125	in	2.93 x 3.86 x 1.93	2.48	2.323 - 2.795
	mm	74.5 x 98 x 49	63	59 - 71
175	in	2.8 x 3.15 x 1.69	2.382	2.07
	mm	71 x 80 x 43	60.6	52.5

Electrical wiring and characteristics

Rating (A)	Solid/multi-core cables		Flexible/crimped-plug cables		Voltage according to IEC 60947-7-1		Voltage according to UL 1059		Short-circuit withstand	
	IEC connection	UL connection	IEC connection	UL connection	AC (V)	DC (V)	AC (V)	DC (V)	I _{cc} (kA)	I _{pk} (kA)
125	1 x 6 - 35 mm ²	-	1 x 6 - 25 mm ²	-	690	1000	600	600	4.2	25
	2 x 4 - 16 mm ²		2 x 4 - 10 mm ²							
	5 x 1.5 - 6 mm ²		5 x 1.5 - 6 mm ²							
175	1 x 10 - 70 mm ²	1 x 8 - 2/0 AWG	1 x 10 - 50 mm ²	1 x 8 - 1/0 AWG	1000	1500			11	30
	6 x 2.5 - 16 mm ²	6 x 14 - 4 AWG	6 x 2.5 - 10 mm ²	6 x 14 - 6 AWG						

Distribution row with IP20 connectors

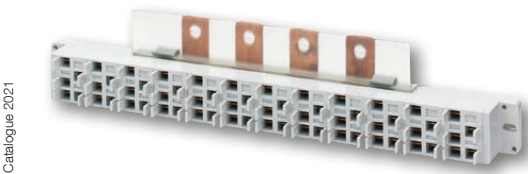

Catalogue 2021

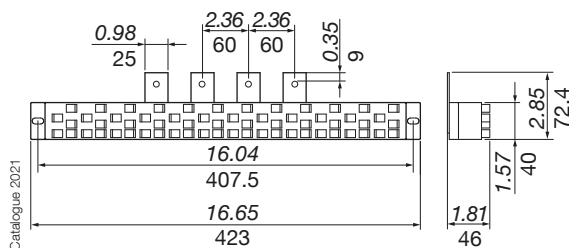

References

Rating (A)	Length	With connecting cords ⁽¹⁾	I _{cc} (kA rms)	Reference
250 ⁽²⁾	1 row	Yes	10	5420 2426
250 ⁽²⁾	1 row	No	10	5421 2426

(1) Supplied with 6 mm² connecting cords, L = 120 mm, 12 black connectors, 12 blue connectors.
(2) Outgoing circuits should be split across the full number of outputs

Accessories

Cables

Rating (A)	Cable type	Length (mm)	Colour	To be ordered in multiples	Reference
40	6 mm ²	120	Blue	10	5421 1006
40	6 mm ²	120	Black	10	5421 1016
40	6 mm ²	320	Blue	10	5421 1106
40	6 mm ²	320	Black	10	5421 1116
63	10 mm ²	320	Blue	10	5421 1101
63	10 mm ²	320	Black	10	5421 1111

Plug-in connectors

Connector type	To be ordered in multiples	Reference
1.5 - 2.5 mm ²	20	5421 0025
4 - 6 mm ²	20	5421 0125

Lug connection

Multi-pole distribution block

References

Rating (A)	N° of poles	I _{cc} (kA rms)	N° of outgoing circuits per section (mm ²)	Reference
160	3 P	10	2 x 95 + 8 x 25	5412 3016
160	4 P	10	2 x 95 + 8 x 25	5412 4016
250	3 P	15	2 x 150 + 8 x 50	5412 3025
250	4 P	15	2 x 150 + 8 x 50	5412 4025
400	3 P	21	2 x 240 + 8 x 95	5412 3040
400	4 P	21	2 x 240 + 8 x 95	5412 4040
630	3 P	21	2 x 300 + 8 x 150	5412 3063
630	4 P	21	2 x 300 + 8 x 150	5412 4063

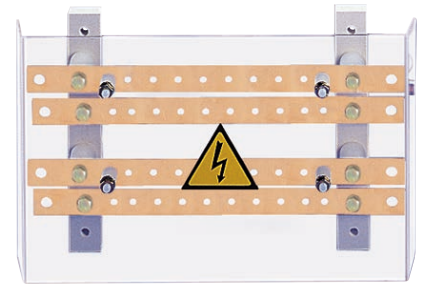

Catalogue 2021

Dimensions (mm)

Rating (A)	N° of poles	Units	A	B	E	H	J	K	Ø L	P	R	T	Ø X	Ø X1	Y
160	3 P	in	6.06	11.26	2.87	1.83	4.80	8.15	0.26	1.42	0.79	0.16	0.35	0.24	2.13
		mm	154	286	73	46.5	122	207	6.5	36	20	4	9	6	54
160	4 P	in	7.48	11.26	2.87	1.83	6.22	8.15	0.26	1.42	0.79	0.16	0.35	0.24	2.13
		mm	190	286	73	46.5	158	207	6.5	36	20	4	9	6	54
250	3 P	in	8.27	12.09	3.27	2.26	1.97	8.7	0.28	1.97	0.98	0.16	0.43	0.31	2.20
		mm	210	307	83	57.5	50	222	7	50	25	4	11	8	56
250	4 P	in	8.27	12.09	3.27	2.26	1.97	8.7	0.28	1.97	0.98	0.16	0.43	0.31	2.20
		mm	260	307	83	57.5	100	222	7	50	25	4	11	8	56
400	3 P	in	11.06	14.76	4.57	3.25	2.56	10.63	0.31	2.56	1.26	0.20	0.57	0.33	3.23
		mm	281	375	116	82.5	65	270	8	65	32	5	14.5	8.5	82
400	4 P	in	13.62	14.76	4.57	3.25	5.12	10.63	0.31	2.56	1.26	0.20	0.57	0.33	3.23
		mm	346	375	116	82.5	130	270	8	65	32	5	14.5	8.5	82
630	3 P	in	10.67	17.24	4.61	3.56	2.56	13.11	0.31	2.56	1.57	0.24	0.57	0.41	3.27
		mm	271	438	117	90.5	65	333	8	65	40	6	14.5	10.5	83
630	4 P	in	13.62	17.24	4.61	3.56	5.12	13.11	0.31	2.56	1.57	0.24	0.57	0.41	3.27
		mm	346	438	117	90.5	130	333	8	65	40	6	14.5	10.5	83

Distribution block with lug connection, frontal protection against indirect contact.

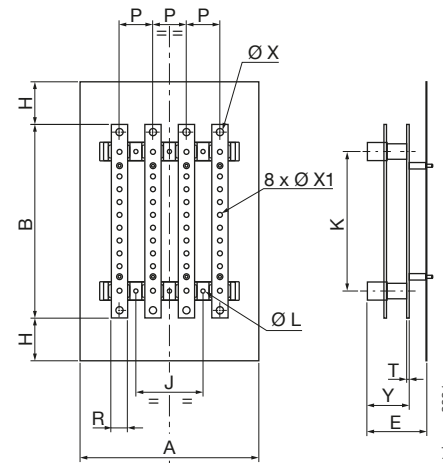

Catalogue 2021

Plug-in for 5 to 6.3 mm bars

References

Rating (A)	N° of poles	Reference
125/160	3 P	3699 3P16
	4 P	3699 6P16
250/400	3 P	3699 3P39
	4 P	3699 6P39
630/800	3 P	3699 3P80
	4 P	3699 6P80

Dimensions (mm)

Rating (A)	N° of poles	Units	A	B	C	D	E	F	G
125/160	3 P	in	3.90	0.79	M8	0.12	0.91	0.39	7.32
		mm	99	20		3	23	10	186
	4 P	in	3.90	0.79		0.12	0.91	0.39	9.76
		mm	99	20		3	23	10	248
250/400	3 P	in	4	0.79	M10	0.16	1.10	0.49	7.32
		mm	101.5	25		4	28	12.5	186
	4 P	in	4	0.98		0.16	1.10	0.49	9.76
		mm	101.5	25		4	28	12.5	248
630/800	3 P	in	4	0.98	M10	0.16	1.10	0.49	7.32
		mm	101.5	25		4	28	12.5	186
	4 P	in	4	0.98		0.16	1.10	0.49	9.76
		mm	101.5	25		4	28	12.5	248

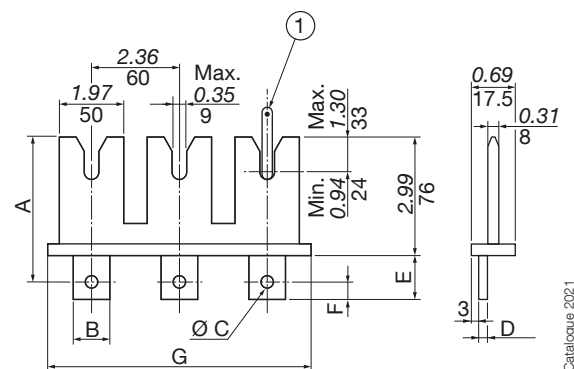

1. Bar thickness 5 to 6.3 mm.

Catalogue 2021

Distribution blocks

Distribution system

Lug connection (cont.)

Split throw multi-pole distribution block

References

Rating (A)	L (mm)	N° of poles	I _{cc} (kA rms)	No of brackets	Distribution block	
					Reference	Protective cover Reference
160	270	4 P	25	2	5028 0421	5028 0411
160	420	4 P	17	2	5028 0451	5028 0412
160	620	4 P	20	3	5028 0471	5028 0413
250	270	4 P	30	2	5028 0423	5028 0411
250	420	4 P	22	2	5028 0453	5028 0412
250	620	4 P	18	3	5028 0473	5028 0413
400	270	4 P	24	2	5028 0425	5028 0411
400	420	4 P	21	2	5028 0455	5028 0412
400	620	4 P	13	3	5028 0475	5028 0413

Type	Cond.	Reference
Spacer adaptor for protection covers	1	5028 0415

Dimensions (mm)

Rating (A)	N° of feeders	Units	A	Ø D	E	L	P	R
160	9	in	9.84	0.31	5.91	10.63	0.20	0.59
		mm	250	8	150	270	5	15
	15	in	15.75	0.31	11.81	16.54	0.20	0.59
		mm	400	8	300	420	5	15
	21	in	23.62	0.31	9.84	24.41	0.20	0.59
		mm	600	8	250	620	5	15
250	9	in	9.84	0.39	5.91	10.63	0.20	0.79
		mm	250	10	150	270	5	20
	15	in	15.75	0.39	11.81	16.54	0.20	0.79
		mm	400	10	300	420	5	20
	21	in	23.62	0.39	9.84	24.41	0.20	0.79
		mm	600	10	250	620	5	20
400	8	in	8.86	0.47	5.91	10.63	0.20	1.26
		mm	225	12	150	270	5	32
	14	in	14.76	0.47	11.81	16.54	0.20	1.26
		mm	375	12	300	420	5	32
	20	in	24.41	0.47	9.84	24.41	0.20	1.26
		mm	620	12	250	620	5	32

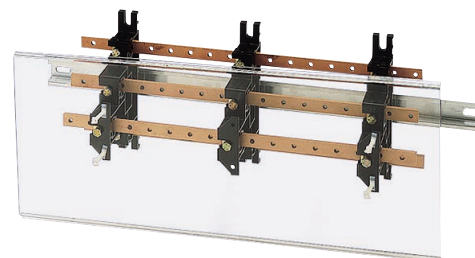

repar_012_b_1_cat

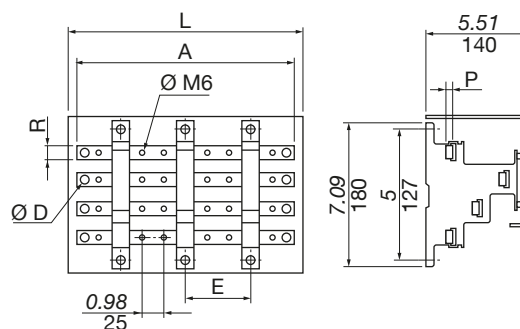

Catalogue 2021

Split throw distribution block, with threaded holes, plugs into symmetrical DIN rail. Comes pre-mounted and without protective cap.

Disconnectable neutral

References

Rating (A)	Connection type	Reference
160	Lug connection	NB16 0000
250	Lug connection	NB25 0000
400	Lug connection	NB40 0000
630	Lug connection	NB63 0000

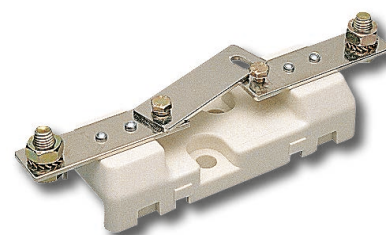

repar_030_a_2_cat

Dimensions (mm)

Rating (A)	Units	A	B	C	D	E	Max. width
160	in	3.94	0.98	3.35	4.61	1.77	1.26
	mm	100	25	85	117	45	32
250	in	5.91	0.98	4.72	6.81	1.77	1.26
	mm	150	25	120	173	45	32
400	in	6.93	0.98	5.91	7.87	2.56	2.17
	mm	176	25	150	200	65	55
630	in	8.27	0.98	6.30	9.45	2.56	2.95
	mm	210	25	160	240	65	75

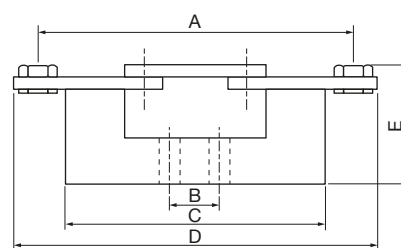

shunt_012_a_1_x_cat

Multi-pole distribution block for SIRCO

References

Rating (A)	N° of poles	I _{cc} (kA rms)	N° of outgoing circuits per section (mm ²)	Reference
160	3 P	10	1 x 95 + 8 x 25	5411 3016
	4 P	10	1 x 95 + 8 x 25	5411 4016
250	3 P	15	1 x 150 + 8 x 50	5411 3025
	4 P	15	1 x 150 + 8 x 50	5411 4025
400	3 P	21	1 x 240 + 8 x 95	5411 3040
	4 P	21	1 x 240 + 8 x 95	5411 4040
630	3 P	21	1 x 300 + 8 x 150	5411 3063
	4 P	21	1 x 300 + 8 x 150	5411 4063

Dimensions (mm)

Rating (A)	N° of poles	Units	A	B	E	H	K	P	R	T	Y
160	3 P	in	6.06	11.26	2.87	1.83	10.30	1.42	0.79	0.16	2.13
		mm	154	286	73	46.5	261.5	36	20	4	54
	4 P	in	7.48	11.26	2.87	1.83	10.30	1.42	0.79	0.16	2.13
		mm	190	286	73	46.5	261.4	36	20	4	54
250	3 P	in	8.27	12.09	3.27	2.26	10.98	1.97	0.98	0.16	2.20
		mm	210	307	83	57.5	279	50	25	4	56
	4 P	in	10.24	12.09	3.27	2.26	10.98	1.97	0.98	0.16	2.20
		mm	260	307	83	57.5	279	50	25	4	56
400	3 P	in	11.06	14.76	4.57	3.25	13.39	2.56	1.26	0.20	3.23
		mm	281	375	116	82.5	340	65	32	5	82
	4 P	in	13.62	14.76	4.57	3.25	13.39	2.56	1.26	0.20	3.23
		mm	346	375	116	82.5	340	65	32	5	82
630	3 P	in	10.67	17.24	4.61	3.56	16.16	2.56	1.57	0.24	3.27
		mm	271	438	117	90.5	410.5	65	40	6	83
	4 P	in	13.62	17.24	4.61	3.56	16.16	2.56	1.57	0.24	3.27
		mm	346	438	117	90.5	410.5	65	40	6	83

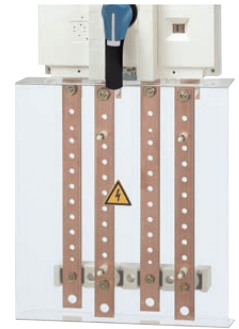

repair_020_b_1_cat

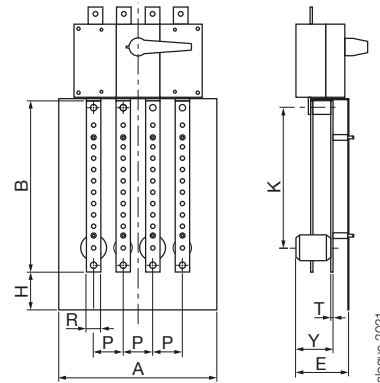

Distribution block with lug connection, frontal protection against non-intentional contact (load break switching device not included).

Catalogue 2021

Multi-pole distribution block for FUSERBLOC and SIRCO VM2

References

Rating (A)	Fuse size	N° of poles	Device	N° of outgoing circuits per section (mm ²)	Reference
100/125/160	22x58 / 00	3 P	FUSERBLOC	10x16 + 2x35 + 3xM6	5413 3016
		4 P		10x16 + 2x35 + 3xM6	5413 4016
160	0	3 P		10x16 + 2x35 + 3xM6	5413 3017
		4 P		10x16 + 2x35 + 3xM6	5413 4017
250	1	3 P		11 x M8	5413 3025
		4 P		11 x M8	5413 4025
400	2	3 P	11 x M8	5413 3040 ⁽¹⁾	
		4 P	11 x M8	5413 4040 ⁽¹⁾	
160 / 200		3 P	SIRCO VM2	10x16 + 2x35 + 3xM6	5413 3020
		4 P		10x16 + 2x35 + 3xM6	5413 4020

⁽¹⁾ *Distribution block compatible only with 400A Fuserbloc fuse reference 3xxx xx39

Dimensions (mm)

Rating (A)	N° of poles	Device	Units	A	B	E	H	K	P	R	T	Y
100 / 125 / 160	3 P	FUSERBLOC	in	4.33	10.24	2.40	0.79	9.17	1.42	0.79	0.16	1.54
			mm	110	260	61	20	233	36	20	4	39
	4 P		in	5.71	10.24	2.40	0.79	9.17	1.42	0.79	0.16	1.54
			mm	145	260	61	20	233	36	20	4	39
160	3 P		in	5.91	10.24	2.40	0.79	9.17	1.97	0.79	0.16	1.54
			mm	150	260	61	20	233	50	20	4	39
	4 P	in	7.87	10.24	2.40	0.79	9.17	1.97	0.79	0.16	1.54	
		mm	200	260	61	20	233	50	20	4	39	
250	3 P	in	7.68	13.39	2.64	0.59	11.81	2.36	1.26	0.20	1.77	
		mm	185	340	67	15	300	60	32	5	45	
	4 P	in	9.65	13.39	2.64	0.59	11.81	2.36	1.26	0.20	1.77	
		mm	245	340	67	15	300	60	32	5	45	
400	3 P	in	8.27	13.39	2.64	0.59	11.81	2.60	1.26	0.20	1.77	
		mm	210	340	67	15	300	66	32	5	45	
	4 P	in	10.83	13.39	2.64	0.59	11.81	2.60	1.26	0.20	1.77	
		mm	275	340	67	15	300	66	32	5	45	
160 / 200	3 P	SIRCO VM2	in	5.59	10.24	2.40	0.79	9.17	1.08	0.79	0.16	1.54
			mm	142	260	61	20	233	27.5	20	4	39
	4 P		in	5.59	10.24	2.40	0.79	9.17	1.08	0.79	0.16	1.54
			mm	142	260	61	20	233	27.5	20	4	39



repair_013_a_2_cat

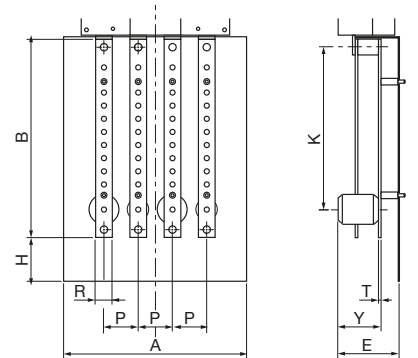

Catalogue 2021